

bm

bulut makina

*Asansöre dair her şey...*



Orhanlı Mh. Katip Çelebi Cd. N:17 34956 Tuzla - İstanbul / TÜRKİYE  
T: +90 (216) 394 50 50 (pbx) F: + 90 216 394 50 54 E: sales@bulutmakina.com

www.bulutmakina.com

Basım: 18.03.2017  
ZE Kopyalama Baskı  
Çözümleri Rek. Bil.  
Paz. Tic. Ltd. Şti.



www.kosgeb.gov.tr

bm

bulut makina

*Asansöre dair her şey...*



1988 yılında kurulan Bulut Makina bugün 10.000m<sup>2</sup> fabrikasında %100 lazer kesim teknolojisiyle üretimine devam etmektedir. 1995 yılından beri Fermator - İspanya otomatik kapıları ve 2000 yılından beri GMV - İtalya hidrolik ünitelerinin Türkiye distribütörlüğünü sürdürmekte olup, 2010 yılında Sicor - İtalya Asansör makinalarının ve 2013 yılında da Marazzi - İtalya raylarının Türkiye tek yetkili distribütörlüğüne de başlamıştır. Bulut Makina paket asansör ve her tip asansör malzemesi satışında yurtiçi ve yurtdışında sektördeki öncü firmalardandır.

Bulut Makina asansör sektöründe kalite ve güvenilirliği temsil etmesinin yanısıra, üretimde kullanılan malzeme kalitesi, "lego tipi" üretim bandı ve montaj tekniği, müşterisine sunduğu geniş ürün yelpazesıyla, müşterilerin özel projelerine akılcı çözümler getirmektedir. Konusunda uzman geniş bir mühendis kadrosuyla çalışmakta olup, satılan her ürünün satış sonrası teknik desteğini verebilecek tecrübeli mühendis ve teknisyen kadrosunu da bünyesinde barındırmaktadır.

Bulut Makina established in 1988 continues its manufacturing with the technology of 100 % laser-cut in its 10.000m<sup>2</sup> factory, today. It has been preserving the Turkish distributorship of Fermator - Spain automatic doors starting from 1995 and GMV - Italy hydraulic units starting from 2000; and also started to distribute Sicor - Italy traction machines in 2010 and Marazzi guiderrails as its exclusive distributor in 2013. Bulut Makina is one of the leader companies in Turkey which supply complete lift packages and also all kinds of lift components in both local and international markets.

Bulut Makina represents the quality and reliability in the lift market; besides works with its wide range of competent engineer cadre offering reasonable solutions for customers' special projects under favour of the material quality used in production, "lego type" mass production line and production techniques and the wide range of product presented to its customers; It also embodies the experienced engineer and technician cadre being able to give the technic support after the sale of every product.

Bulut Makina étant fondé en 1988 continue son production avec le technology de 100 % coupe au laser dans la fabrique de 10.000m<sup>2</sup>, aujourd'hui. Il préserve le distribution turque de Fermator - Espagne portes automatiques depuis 1995 et GMV - Italy unités hydrauliques depuis 2000 ; et aussi a commencé à distribuer Sicor - Italie machines en 2010 et Marazzi - Italie rails de guidage comme son distributeur exclusif in 2013. Bulut Makina est l'un des sociétés prépondérantes en Turquie que fournit les paquets complets d'ascenseur et aussi toutes les sortes des composants d'ascenseur dans les marchés locaux et internationaux.

Bulut Makina représente la qualité et la fiabilité dans le secteur d'ascenseur ; en outre travaille avec son cadre d'ingénieur competent qui propose les solutions raisonnables pour les projets spéciaux des clients à la faveur de la qualité de matériel appliqué à la production, la ligne masse de production « type de lego », le technique de montage et une chaine grande de produit soumise à ses clients ; et également comprend un cadre large d'ingénieur et technicien expérimenté qui peut donner le support technique après le vente des chaque produit.



TSE Sürdürülebilir Kalite Anlayışı ile  
Hizmet Veren Kuruluşlar  
Altın Ödülü (2013)



# KAPI SİSTEMLERİ

DOOR SYSTEMS / SYSTEMES de PORTE



**Bulut Makina olarak otomatik kapı alanında yılların getirdiği tecrübe sonucunda 2009 yılında kendi markamız olan MB ile otomatik kapı üretimine başladık. Öncelikli hedefimiz piyasada yoğun olarak üretilmeyen serilerin pazara sunulmasıydı. Bu amaçla öncelikle ürün yelpazemizi 600 mm den 6000 mm ye kadar çok geniş tuttuk. Bunun yanı sıra standart, ince, ekstra ince ve ağır hizmet-yoğun trafik serileri ile de farklı otomatik kapı uygulamaları için farklı çözümler ürettik.**

We have started automatic door production in 2009 under our own brand MB as a result of our experience in this field. Our primary target was to supply the products which were not supplied sufficiently to the market. As a result we planned our product range wide as from 600 mm to 6000 mm and developed several series for various automatic door applications. These are standart, thin, extra thin and heavy-duty series.

Nous avons commencé la production de portes automatiques en 2009 sous notre propre marque MB grâce à notre expérience dans ce domaine. Notre objectif principal était de fournir les produits qui ne sont pas suffisamment fournis au marché. Ainsi nous prévu de notre gamme de produits large à partir de 600 mm à 6000 mm et mis au point plusieurs séries pour diverses applications de portes automatiques. Voici les standart, série mince, très mince et poids lourds.

OTOMATİK KAPILAR  
AUTOMATIC DOORS | PORTES AUTOMATIQUES



**Teleskobik 2 Panel Kat Kapısı**  
2 Panels Telescopic Landing Door  
Porte Palière Télescopique 2 Vantaux

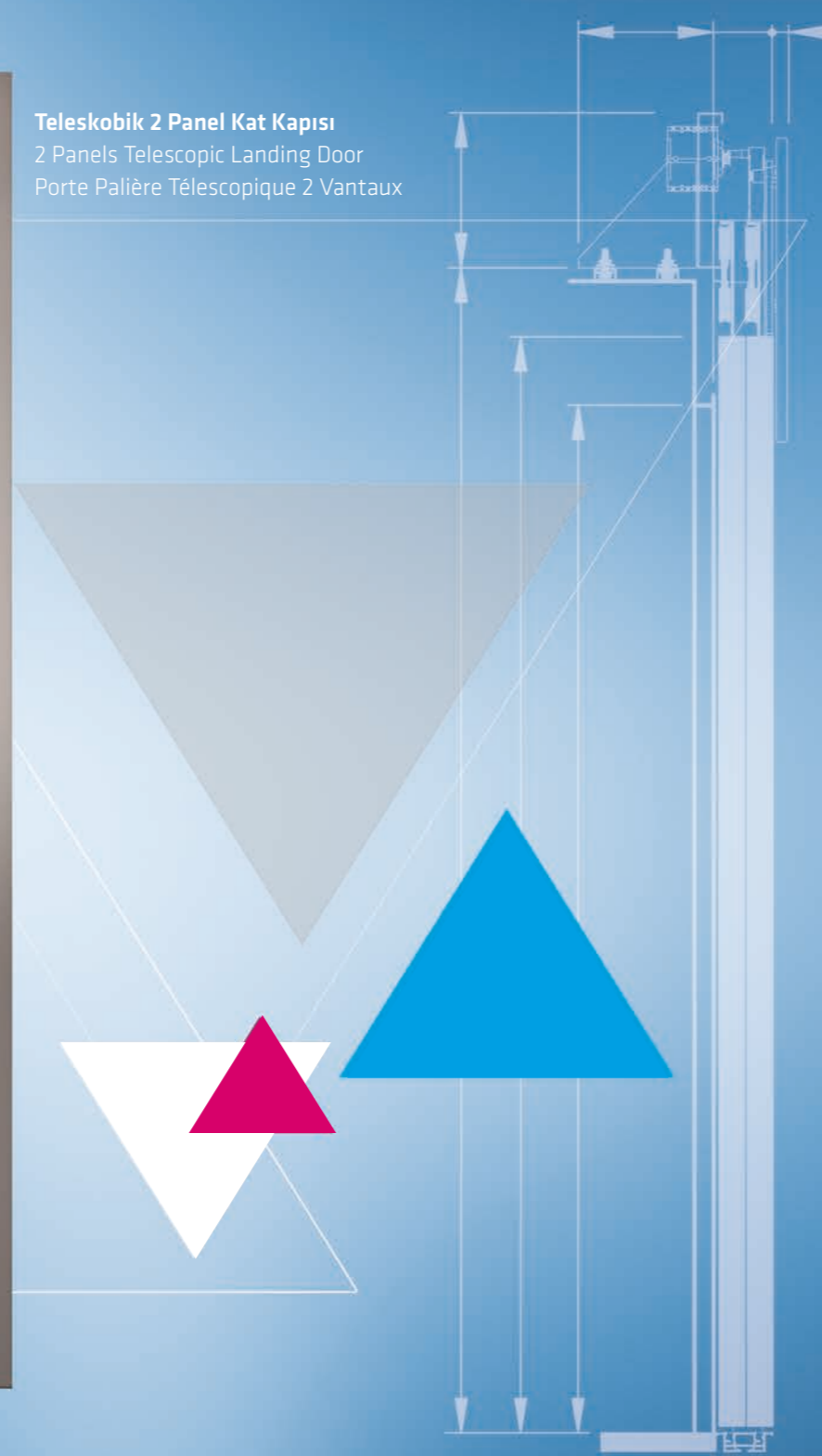

**Merkezi 2 Panel Kat Kapısı**  
2 Panels Central Opening Landing Door  
Porte Palière Ouverture Centrale 2 Vantaux



**Merkezi 4 Panel Kat Kapısı**  
4 Panels Central Opening Landing Door  
Porte Palière Ouverture Centrale 4 Vantaux



**Teleskobik 3 Panel Kat Kapısı**  
3 Panels Telescopic Landing Door  
Porte Palière Télescopique 3 Vantaux





**Modernizasyon Kasa Merkezi 4 Panel Kat Kapısı**  
4 Panels Central Landing Door with Modernization Frame  
Porte Palière avec Cadre Modernisation, Ouverture Centrale 4 Vantaux

**Söveli Kasa Merkezi 2 Panel Kat Kapısı**  
2 Panels Central Opening Landing Door with Adjustable Door Jamb  
Porte Palière avec Jambage de Porte Réglable,  
Ouverture Centrale 2 Vantaux

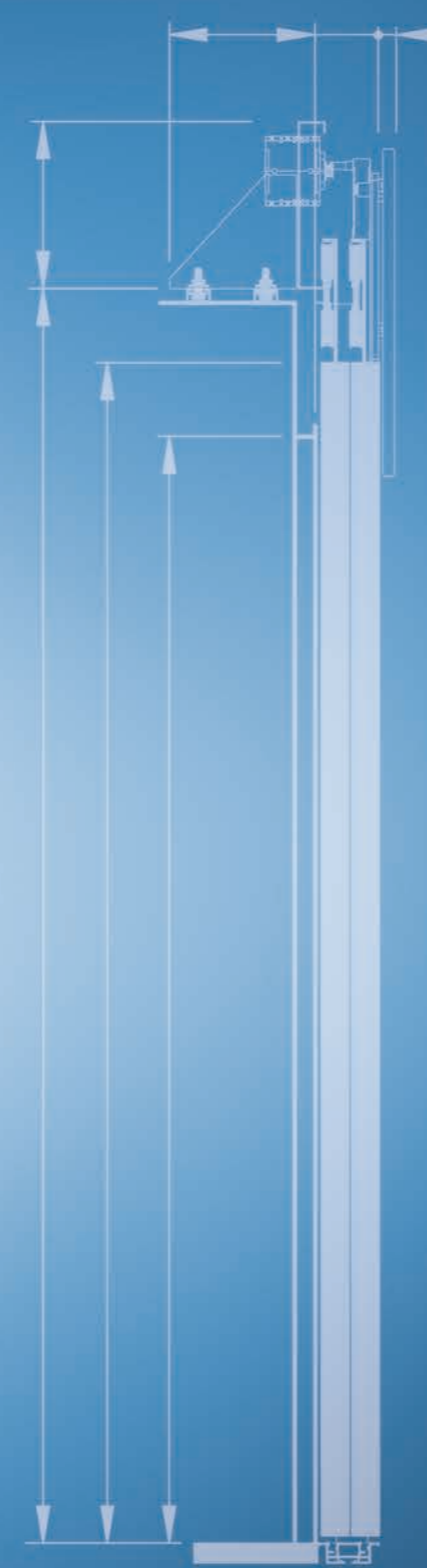

**Kasasız Sistem Teleskobik 2 Panel Kat Kapısı**  
2 Panels Telescopic Frameless Landing Door  
Porte Palière sans Cadre Télescopique 2 Vantaux

**Teleskobik 2 Panel Boncuklu Kat Kapısı**  
2 Panels Telescopic Landing Door with Beads  
Porte Télescopique 2 Vantaux avec Boule



**Merkezi 2 Panel Ahşap Kaplamalı Kapı**  
2 Panels Central Opening Landing Door with Wooden Coating  
Porte Palière en Bois Plaqué Ouverture Centrale 2 Vantaux

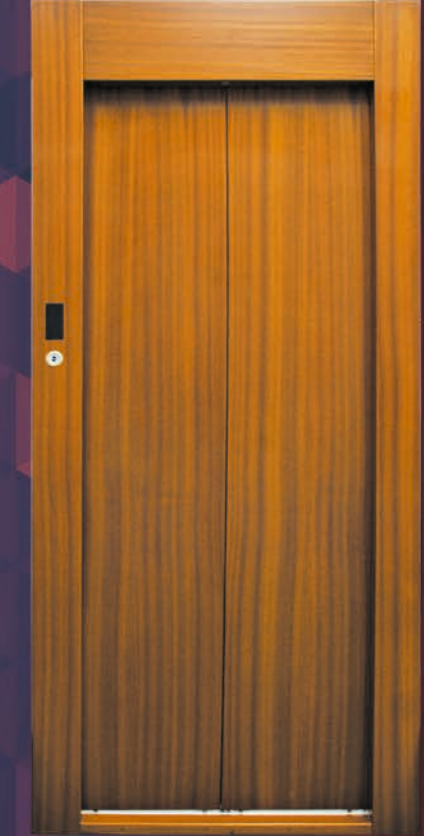



**Merkezi 2 Panel Kabin Operatörü**  
2 Panels Central Opening Car Door Operator  
Opérateur de Porte Cabine Ouverture Centrale, 2 Vantaux



**Teleskobik 2 Panel Kabin Operatörü**  
2 Panels Telescopic Car Door Operator  
Opérateur de Porte Cabine Télescopique, 2 Vantaux



**Teleskobik 3 Panel Kabin Operatörü**  
3 Panels Telescopic Car Door Operator  
Opérateur de Porte Cabine Télescopique, 3 Vantaux

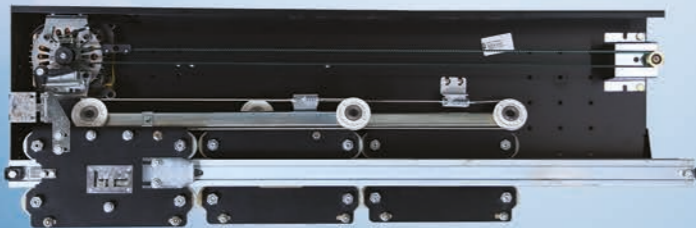

**Teleskobik 3 Panel İnce Seri Kabin Operatörü**  
Slim Series 3 Panels Telescopic Car Door Operator  
Opérateur de Porte Cabine Télescopique, 3 Vantaux, Série Slim

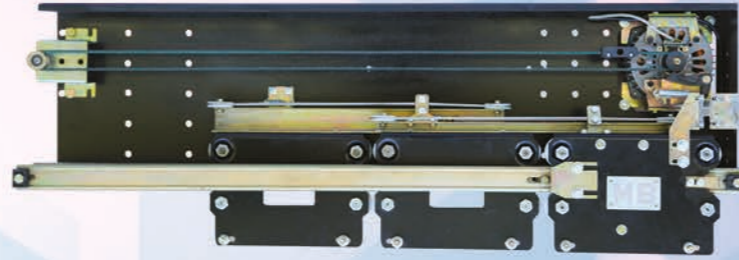

**Teleskobik 3 Panel Kat Mekanizması**  
3 Panels Telescopic Landing Door Mechanism  
Mécanisme de Porte Palière, Télescopique, 3 Vantaux



**Merkezi 4 Panel Kat Mekanizması**  
4 Panels Central Opening Landing Door Mechanism  
Mécanisme de Porte Palière, Ouverture Centrale, 4 Vantaux



**Merkezi 2 Panel Kat Mekanizması**  
2 Panels Central Opening Car Door Operator  
Opérateur de Porte Cabine Ouverture Centrale, 2 Vantaux

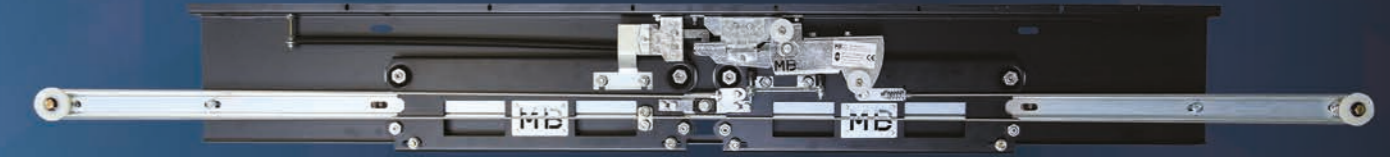

**Teleskobik 2 Panel Kat Mekanizması**  
2 Panels Telescopic Landing Door Mechanism  
Mécanisme de Porte Palière, Télescopique, 2 Vantaux



KABİN OPERATÖRLERİ

OPERATORS | OPERATEURS

KAT MEKANİZMALARİ

MECHANISMS | MECHANISMES



# KABINLER

CABINS / CABINES





## BK 130-301

- Duvarlar Walls** Boncuklu RAL Boyalı Lamine Cam  
RAL Painted Laminated Glass with Beads
- Murs** Verre stratifié Peint RAL avec des Boules
- Aksesuarlar Accessories Accessoires** Paslanmaz  
Stainless Steel  
Inoxydable
- Küpeşte Handle Main Courante** Paslanmaz Boru K1  
Stainless Steel Tube K1  
Tube Inoxydable K1
- Tavan Ceiling Plafond** Geniş Bombeli Tavan  
(Üstten Şerit LED / Spot Aydınlatma)  
Wide Curved  
(Upper Strip LED / Spotlights)  
Large Courbe  
(Bande Supérieur LED/ Projecteurs)
- Taban Floor Plancher** Verda Guatemala Doğal Granit  
(Paslanmaz Çıtalı)  
Naturel Granit Verda Guatemala  
(with S/S Bars)  
Granite Naturel Guatemala ( avec Barre en Inox)

Tüm kabinler farklı tavan, aksesuar, döşeme veya taban seçenekleri ile kombine edilebilir.

All cabins can be combined with different ceiling, accessories, floor/wall coating.

Toutes les cabines peuvent être combinées avec différent plafond, accessoire, base/revêtement mural.

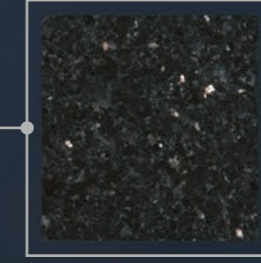
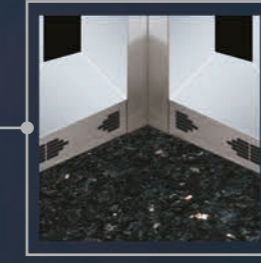
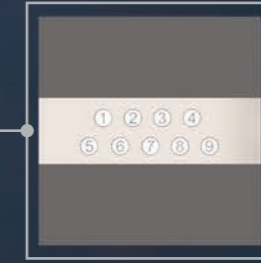
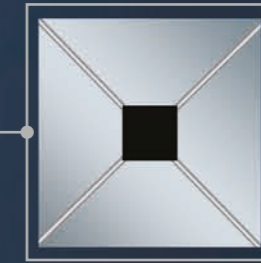
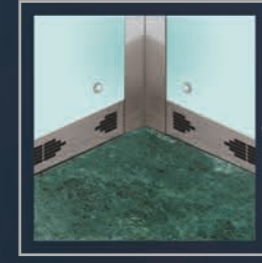
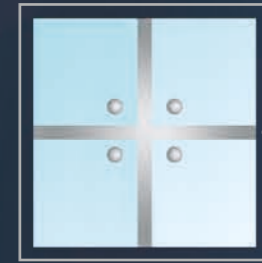

## BK 110-301

- Duvarlar Walls** Sekizgen Paslanmaz / ESB Boyalı Sac  
Octagonal Stainless Steel / ESB  
Painted Steel Sheet
- Murs** Cier inoxydable Octogona l/ Plaque  
en Acier Peint ESB
- Aksesuarlar Accessories Accessoires** Paslanmaz  
Stainless Steel  
Inoxydable
- Küpeşte Handle Main Courante** Yatay Kabin Kasedi  
Horizontal Car Operating Panel  
Boîte à Bouton Cabine Horizontale
- Tavan Ceiling Plafond** Geniş Bombeli Tavan  
(Üstten Şerit LED / Spot Aydınlatma)  
Wide Curved  
(Upper Strip LED / Spotlights)  
Large Courbe  
(Bande Supérieur LED/ Projecteurs)
- Taban Floor Plancher** Star Galaxy Doğal Granit  
Natural Granite Star Galaxy  
Granite Naturel Galaxy

Tüm kabinler farklı tavan, aksesuar, döşeme veya taban seçenekleri ile kombine edilebilir.

All cabins can be combined with different ceiling, accessories, floor/wall coating.

Toutes les cabines peuvent être combinées avec différent plafond, accessoire, base/revêtement mural.

**KABINLER**  
CABINS | CABINES



## BK 160-101

► **Duvarlar**  
Walls  
Murs

Boyuna Postforming Laminat  
Vertical Postforming Laminate  
Postformage Laminant Vertical

► **Aksesuarlar**  
Accessories  
Accessoires

Paslanmaz  
Stainless Steel  
Inoxydable

► **Küpeşte**  
Handle  
Main Courante

Paslanmaz Boru K1  
Stainless Steel Tube K1  
Tube Inoxydable K1

► **Tavan**  
Ceiling  
Plafond

Standart Tavan  
Standart Ceiling  
Plafond Standard

► **Taban**  
Floor  
Plancher

Rosa Porino Doğal Granit  
Natural Granite Rosa Porino  
Granite Naturel Rosa Porino

Tüm kabinler farklı tavan, aksesuar, döşeme veya taban seçenekleri ile kombine edilebilir.

All cabins can be combined with different ceiling, accessories, floor/wall coating.

Toutes les cabines peuvent être combinées avec différent plafond, accessoire, base/revêtement mural.

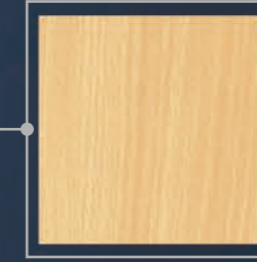
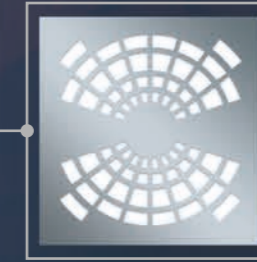
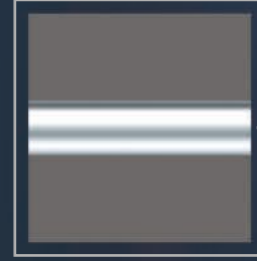
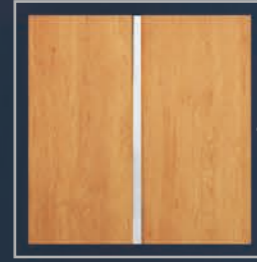

## BK 60-102

► **Duvarlar**  
Walls  
Murs

Yekpare Laminat  
One Sheet Laminate  
Une-plaque Stratifié

► **Aksesuarlar**  
Accessories  
Accessoires

Paslanmaz  
Stainless Steel  
Inoxydable

► **Küpeşte**  
Handle  
Main Courante

Paslanmaz Boru K1  
Stainless Steel Tube K1  
Tube Inoxydable K1

► **Tavan**  
Ceiling  
Plafond

Kuasar A9  
Quasar A9  
Quasar A9

► **Taban**  
Floor  
Plancher

PVC  
PVC  
PVC

Tüm kabinler farklı tavan, aksesuar, döşeme veya taban seçenekleri ile kombine edilebilir.

All cabins can be combined with different ceiling, accessories, floor/wall coating.

Toutes les cabines peuvent être combinées avec différent plafond, accessoire, base/revêtement mural.



## BK 160-201

- Duvarlar**  
Walls  
Murs  
Enine Postforming Laminat  
Horizontal Postforming Laminate  
Postformage Stratifié Horizontale
- Aksesuarlar**  
Accessories  
Accessoires  
Paslanmaz  
Stainless Steel  
Inoxydable
- Küpeşte**  
Handle  
Main Courante  
Paslanmaz Boru K1  
Stainless Steel Tube K1  
Tube Inoxydable K1
- Tavan**  
Ceiling  
Plafond  
Kuasar A9  
Quasar A9  
Quasar A9
- Taban**  
Floor  
Plancher  
Bianco Sardo Doğal Granit  
Natural Granite Bianco Sardo  
Granite Naturel Bianco Sardo

Tüm kabinler farklı tavan, aksesuar, döşeme veya taban seçenekleri ile kombine edilebilir.

All cabins can be combined with different ceiling, accessories, floor/wall coating.

Toutes les cabines peuvent être combinées avec différent plafond, accessoire, base/revêtement mural.

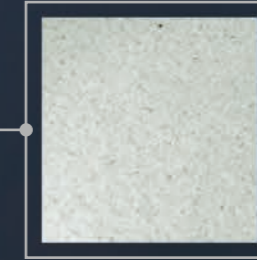
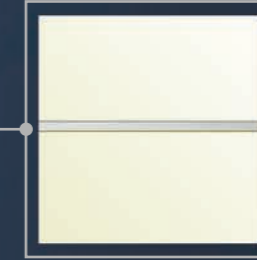
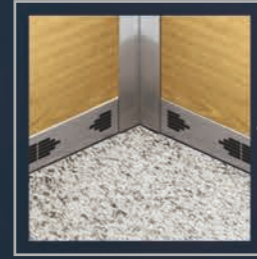
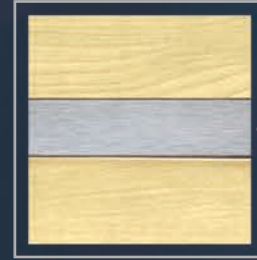
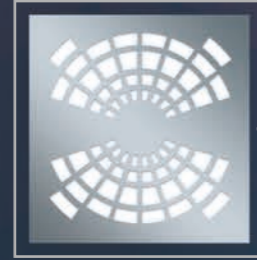

## BK 90-201

- Duvarlar**  
Walls  
Murs  
Enine Laminant  
Horizontal Laminate  
Stratifié Horizontal
- Aksesuarlar**  
Accessories  
Accessoires  
Paslanmaz  
Stainless Steel  
Inoxydable
- Küpeşte**  
Handle  
Main Courante  
Paslanmaz Boru K1  
Stainless Steel Tube K1  
Tube Inoxydable K1
- Tavan**  
Ceiling  
Plafond  
Kuasar A9  
Quasar A9  
Quasar A9
- Taban**  
Floor  
Plancher  
PVC  
PVC  
PVC

Tüm kabinler farklı tavan, aksesuar, döşeme veya taban seçenekleri ile kombine edilebilir.

All cabins can be combined with different ceiling, accessories, floor/wall coating.

Toutes les cabines peuvent être combinées avec différent plafond, accessoire, base/revêtement mural.



## BK 110-101

- ▶ **Duvarlar**  
**Walls**  
**Murs** Boyuna Paslanmaz  
Vertical Stainless Steel  
Vertical Inoxydable
- ▶ **Aksesuarlar**  
**Accessories**  
**Accessoires** Paslanmaz  
Stainless Steel  
Inoxydable
- ▶ **Küpeşte**  
**Handle**  
**Main Courante** Paslanmaz Boru K1  
Stainless Steel Tube K1  
Tube Inoxydable K1
- ▶ **Tavan**  
**Ceiling**  
**Plafond** Kuasar A8  
Quasar A8  
Quasar A8
- ▶ **Taban**  
**Floor**  
**Plancher** Bianco Sardo Doğal Granit  
Natural Granite Bianco Sardo  
Granite Naturel Bianco Sardo

Tüm kabinler farklı tavan, aksesuar, döşeme veya taban seçenekleri ile kombine edilebilir.

All cabins can be combined with different ceiling, accessories, floor/wall coating.

Toutes les cabines peuvent être combinées avec différent plafond, accessoire, base/revêtement mural.

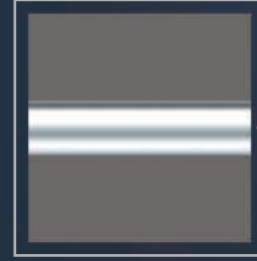

## BK 120-201

- ▶ **Duvarlar**  
**Walls**  
**Murs** Postforming Laminat / Paslanmaz  
Postforming Laminate/ Stainless  
Postformage stratifié / Inoxydable
- ▶ **Aksesuarlar**  
**Accessories**  
**Accessoires** Paslanmaz  
Stainless Steel  
Inoxydable
- ▶ **Küpeşte**  
**Handle**  
**Main Courante** Paslanmaz Boru K6  
Stainless Steel Tube K6  
Tube Inoxydable K6
- ▶ **Tavan**  
**Ceiling**  
**Plafond** Centa  
Centa  
Centa
- ▶ **Taban**  
**Floor**  
**Plancher** Rosa Porino Doğal Granit  
Natural Granite Rosa Porino  
Granit Naturel Rosa Porino

Tüm kabinler farklı tavan, aksesuar, döşeme veya taban seçenekleri ile kombine edilebilir.

All cabins can be combined with different ceiling, accessories, floor/wall coating.

Toutes les cabines peuvent être combinées avec différent plafond, accessoire, base/revêtement mural.

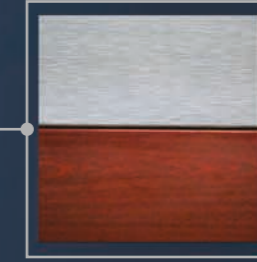



## BK 130-201

- Duvarlar**  
Walls  
Murs
- Aksesuarlar**  
Accessories  
Accessoires
- Küpeşte**  
Handle  
Main Courante
- Tavan**  
Ceiling  
Plafond
- Taban**  
Floor  
Plancher

Enine Lamine Cam  
Horizontal Laminated Glass  
Verre Stratifié Horizontal

Paslanmaz  
Stainless Steel  
Inoxydable

Paslanmaz Boru K6  
Stainless Steel Tube K6  
Tube Inoxydable K6

Kuasar Üst Bombe  
Quasar Concave Up  
Quasar Concave Vers le Haut

Rosa Porrino / Star Glaxy  
Doğal Granit  
Natural Granite  
Rosa Porino / Star Galaxy  
Granite Naturel  
Rosa Porino et Star Galaxy

Tüm kabinler farklı tavan, aksesuar, döşeme veya taban seçenekleri ile kombine edilebilir.

All cabins can be combined with different ceiling, accessories, floor/wall coating.

Toutes les cabines peuvent être combinées avec différent plafond, accessoire, base/revêtement mural.

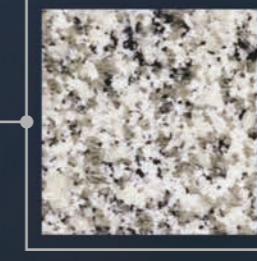
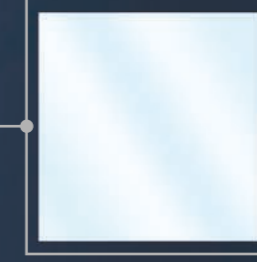
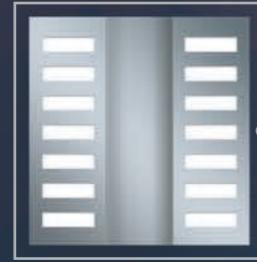

## BK 140-204

- Duvarlar**  
Walls  
Murs
- Aksesuarlar**  
Accessories  
Accessoires
- Küpeşte**  
Handle  
Main Courante
- Tavan**  
Ceiling  
Plafond
- Taban**  
Floor  
Plancher

Lamine Cam  
Laminated Glass  
Verre Stratifié

Paslanmaz  
Stainless Steel  
Inoxydable

Paslanmaz Boru K6  
Stainless Steel Tube K6  
Tube Inoxydable K6

Centa  
Centa  
Centa

Bianco Sardo Doğal Granit  
Natural Granite Bianco Sardo  
Granite Naturel Bianco Sardo

Tüm kabinler farklı tavan, aksesuar, döşeme veya taban seçenekleri ile kombine edilebilir.

All cabins can be combined with different ceiling, accessories, floor/wall coating.

Toutes les cabines peuvent être combinées avec différent plafond, accessoire, base/revêtement mural.



## BK 110-101

- ▶ **Duvarlar**  
**Walls**  
**Murs** Boyuna Paslanmaz  
Vertical Stainless Steel  
Inoxydable Verticale
- ▶ **Aksesuarlar**  
**Accessories**  
**Accessoires** Paslanmaz  
Stainless Steel  
Inoxydable
- ▶ **Küpeşte**  
**Handle**  
**Main Courante** Paslanmaz Boru K1  
Stainless Steel Tube K1  
Tube Inoxydable K1
- ▶ **Tavan**  
**Ceiling**  
**Plafond** Kuasar Üst Bombe  
Quasar Concave Up  
Quasar Concave Vers le Haut
- ▶ **Taban**  
**Floor**  
**Plancher** PVC  
PVC  
PVC

Tüm kabinler farklı tavan, aksesuar, döşeme veya taban seçenekleri ile kombine edilebilir.

All cabins can be combined with different ceiling, accessories, floor/wall coating.

Toutes les cabines peuvent être combinées avec différent plafond, accessoire, base/revêtement mural.

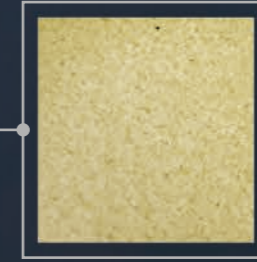
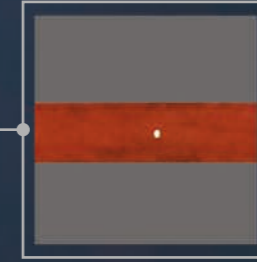
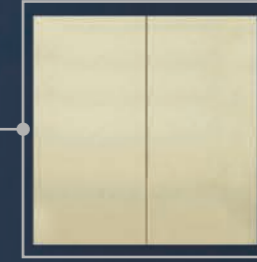
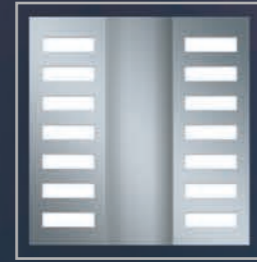

## BK 70-101

- ▶ **Duvarlar**  
**Walls**  
**Murs** Elektrostatik Boyalı Saç  
Epoxy Painted Steel Sheet  
Plaque en Acier Peint Époxy
- ▶ **Aksesuarlar**  
**Accessories**  
**Accessoires** Elektrostatik Boyalı Saç  
Epoxy Painted Steel Sheet  
Plaque en acier peint époxy
- ▶ **Küpeşte**  
**Handle**  
**Main Courante** Werzalit  
Werzalit  
Werzalit
- ▶ **Tavan**  
**Ceiling**  
**Plafond** Standart Tavan  
Standart Ceiling  
Plafond Standard
- ▶ **Taban**  
**Floor**  
**Plancher** PVC  
PVC  
PVC

Tüm kabinler farklı tavan, aksesuar, döşeme veya taban seçenekleri ile kombine edilebilir.

All cabins can be combined with different ceiling, accessories, floor/wall coating.

Toutes les cabines peuvent être combinées avec différent plafond, accessoire, base/revêtement mural.

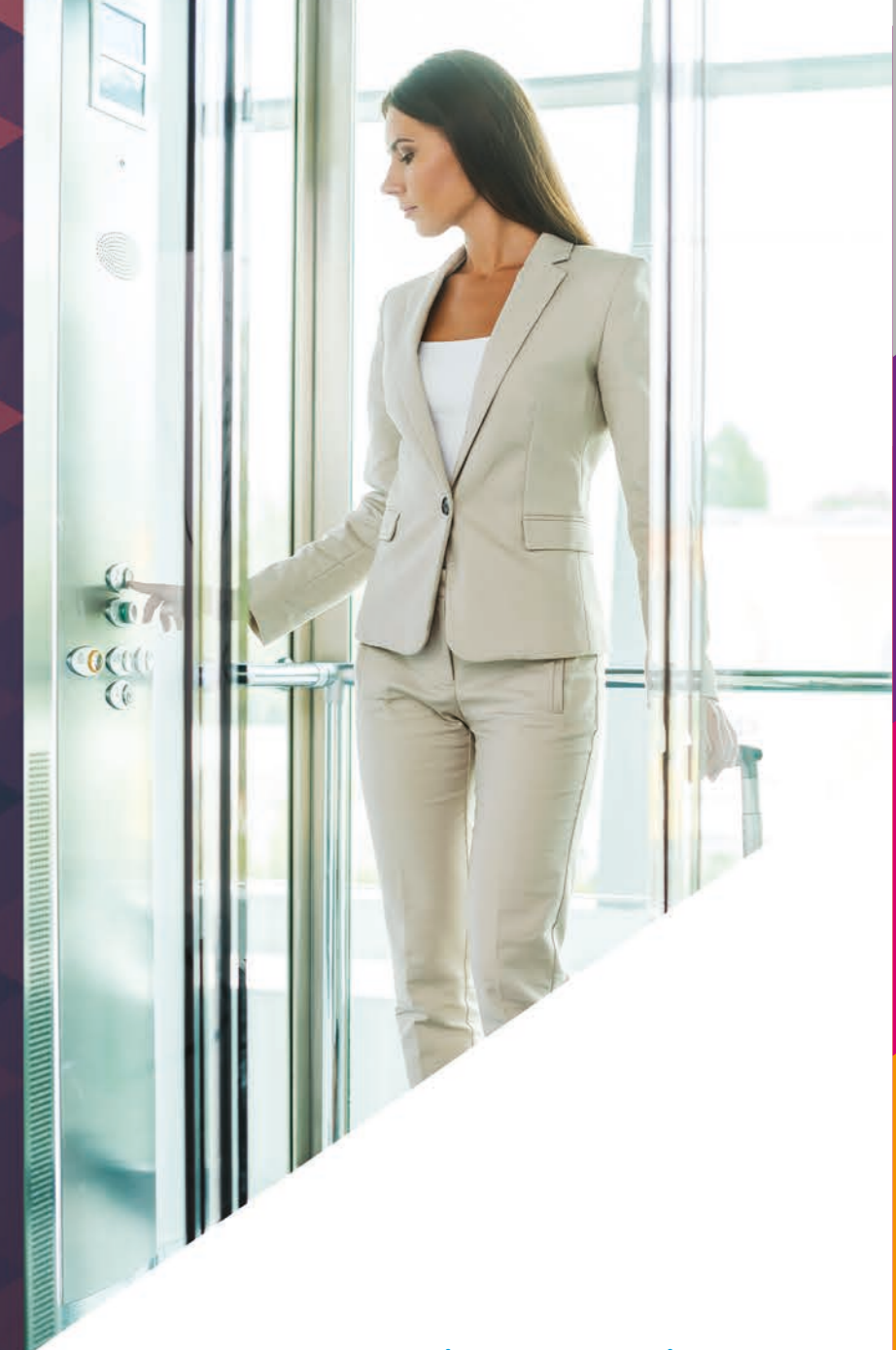
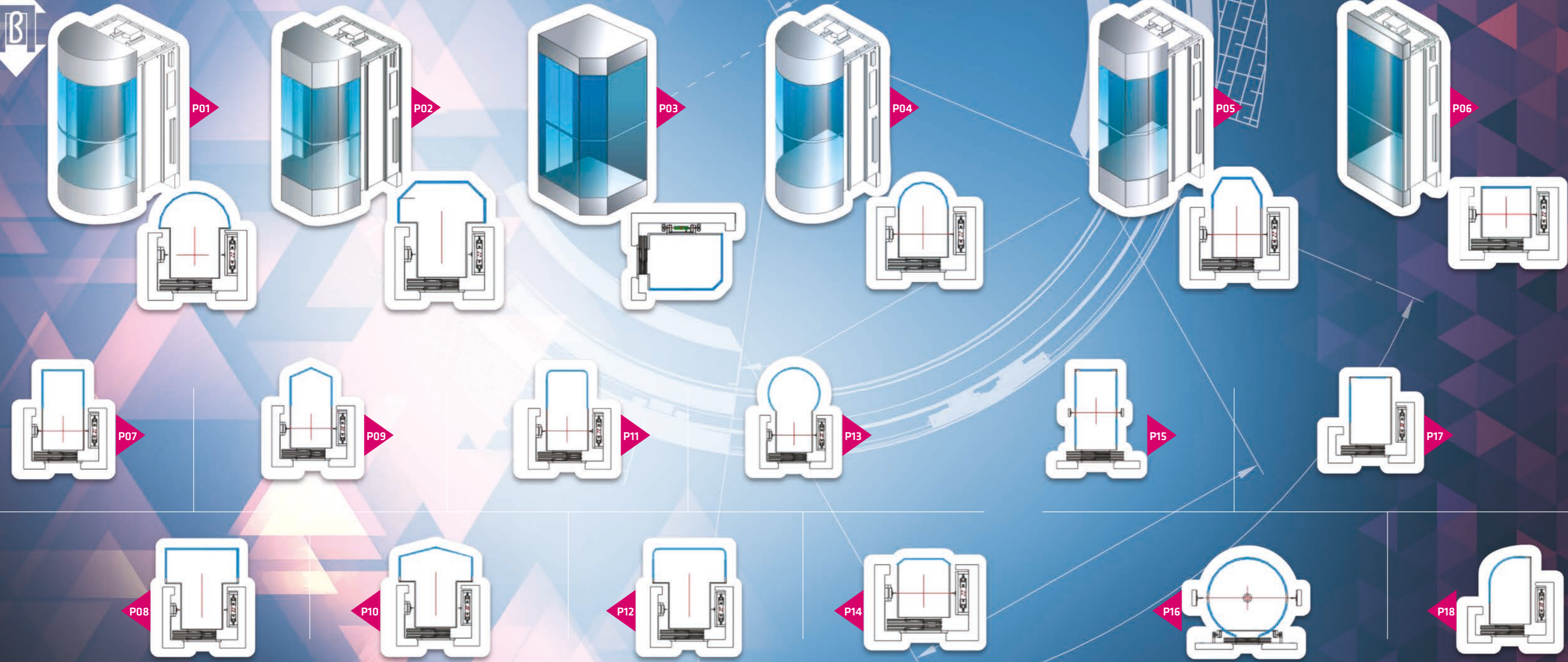

# PANORAMİK KABINLER

PANORAMIC CABINS | CABINES PANORAMIQUES

KABINLER  
CABINS / CABINES

AKSESUARLAR  
ACCESSORIES / ACCESSOIRES

DİSTRİBÜTÖRLÜKLER  
DISTRIBUTORSHIPS / DISTRIBUTIONS



**Semertipi C Karkas**  
C Type Car Frame  
Arcade C



**Semertipi C Karkas**  
C Type Car Frame  
Arcade C



**Semertipi L Karkas**  
L Type Car Frame  
Arcade L

Süspansiyon üretimimiz tamamen lazer kesim saçlarla yapılmaktadır. Semer tipi ve Mekanik Süspansiyonlarımız mukavemet analizi yapılmış olan standart saç büküm profillerle tasarlanmıştır. En ufak vida, delik ve perçine kadar yıllar sonra dahi yedek parçası verilebilecek özelliğe sahip olup, farklı süspansiyon olanakları mevcuttur;

- 1) Standart süspansiyonlar (kuyu dibi 800mm ve üzeri)
- 2) Özel tasarım süspansiyonlar (kuyu dibi 800mm'nin altında)
- 3) Asansör Direktifine uygun çalışan özel sistemler (Kuyu dibi 250mm'ye kadar)
- 4) Makina Direktifine uygun çalışan özel sistemler (Kuyu dibi 100mm'ye kadar)

Our car frame production is realized by way of completely laser-cut metal sheets. L type and Mechanic car frames are designed with standard sheet spinning profiles whose analyses of durability are practised. They have such a speciality that their tiniest spare parts like screw, hole and rivet can be provided even after years, also contain in different opportunities;

- 1) Standard car frames (pit depth of 800mm and upper)
- 2) Special design car frames (pit depth under 800mm)
- 3) Special systems operating as per Lift Directive ( pit depth up to 250mm)
- 4) Special systems operating as per Machine Directive (pit depth up to 100mm)

Notre production de suspension est réalisée par l'entremise des plaques métaux complètement découpées au laser. L type et Mécanique suspensions sont désignées avec les profils standards des plaques fléchies dont les analyses de durabilité sont pratiqués. Ils ont une telle spécialité que leur parts suppléants moindres comme vis, trou et rivet peuvent être fournis même après les années; et aussi contiennent des opportunités différentes;

- 1) Suspensions standards ( le fond de puits de 800mm et plus)
- 2) Suspensions désignées spécialement ( le fond de puits en dessous de 800mm)
- 3) Systèmes spéciaux opérants conformément a la directive d'ascenseur (le fond de puits jusqu'à 250mm)
- 4) Systèmes spéciaux opérants conformément a la directive de machine (le fond de puits jusqu'à 100mm)

**SÜSPANSİYONLAR**

CAR FRAMES | ARCADES





**Üstten Askılı Karkas**  
Upper Fixing Car Frame  
Fixation Supérieur de l'Arcade



**Mekanik 1:1 Süspansiyon**  
Mechanic 1:1 Car Frame  
Arcade 1:1 Mécanique



**Yandan Palangalı Süspansiyon**  
Car Frame with Sided Pulley  
Arcade avec Poulie sur le Côté



**Yardımcı Palangalı Süspansiyon**  
Car Frame with Support Pulley  
Arcade avec Poulie de Support

**Semertipi C Karkas**  
C Type Car Frame  
Arcade C



**SÜSPANSİYONLAR**  
CAR FRAMES | ARCADES

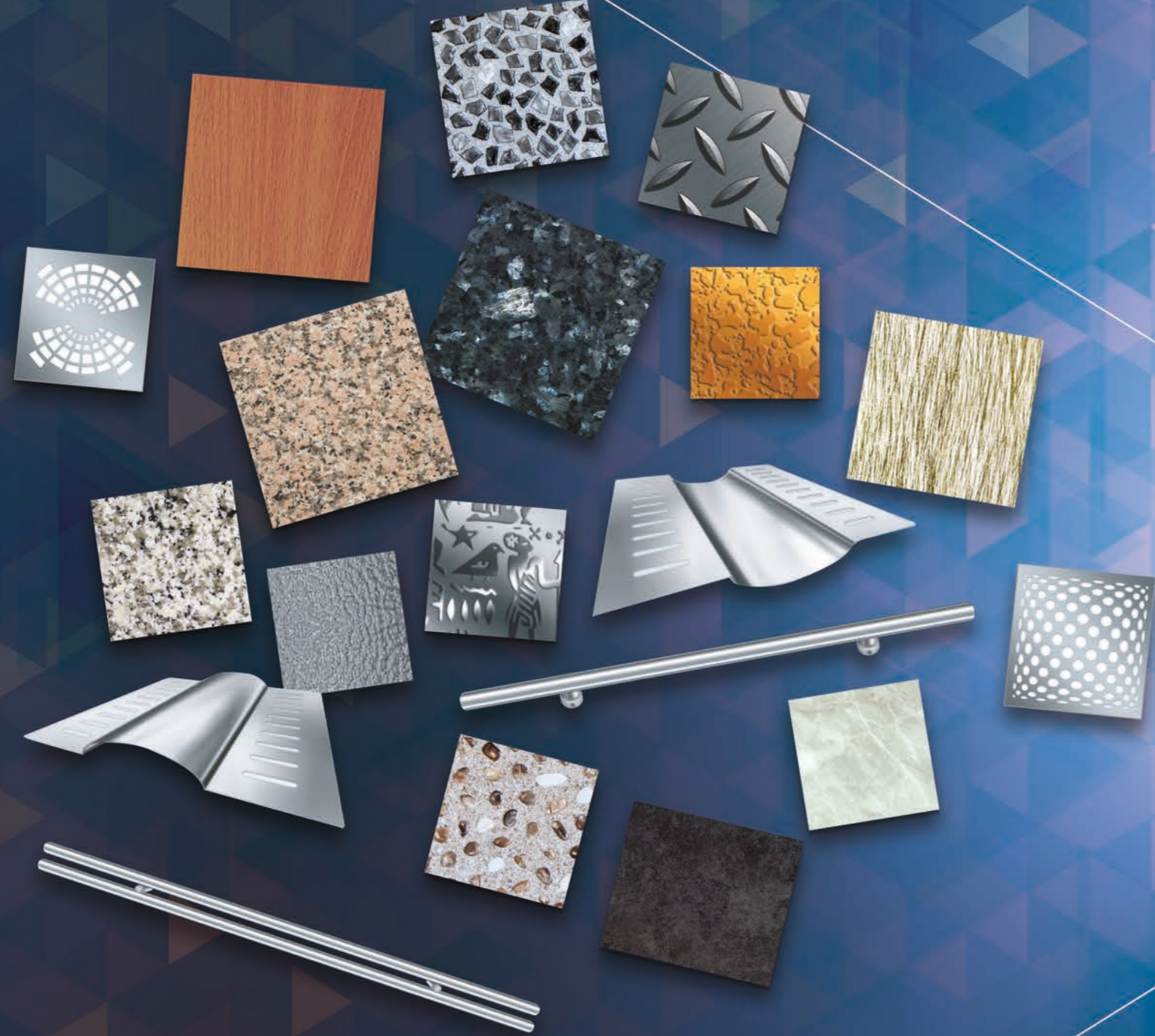

# AKSESUARLAR

ACCESSORIES / ACCESSOIRES

## DEKORASYON MALZEMELERİ

DECORATION MATERIALS | MATERIALS DE DECORATION

### Paslanmazlar

Stainless Steels | Inoxydables

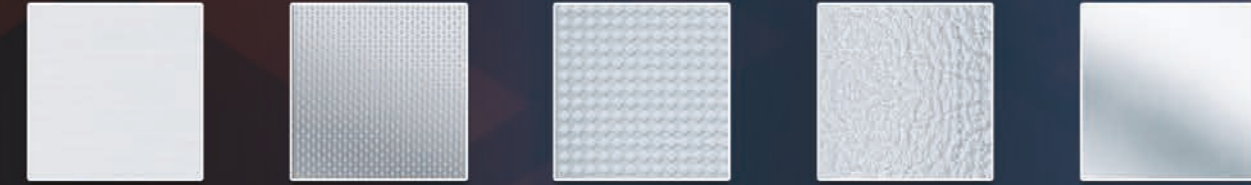

Satine  
Hairline

Noktalı  
Dotted

Kare  
Square

Deri  
Leather

Mat Ayna  
Dull Mirror

### Dekoratif Paslanmazlar

Decorative Stainless Steels | Aciers Inoxydables Décoratifs



YH-M

M-GD

YH-E03

YH-GE08

YH-E02

YH-GE02

YH-E10

H-RG

### Küpeşterler

Handles | Poignées



K1

K2

K3

K4

K5

K6

## KUASAR TAVAN MODELLERİ

QUASAR CEILING MODELS | MODELES DE QUASAR PLAFOND

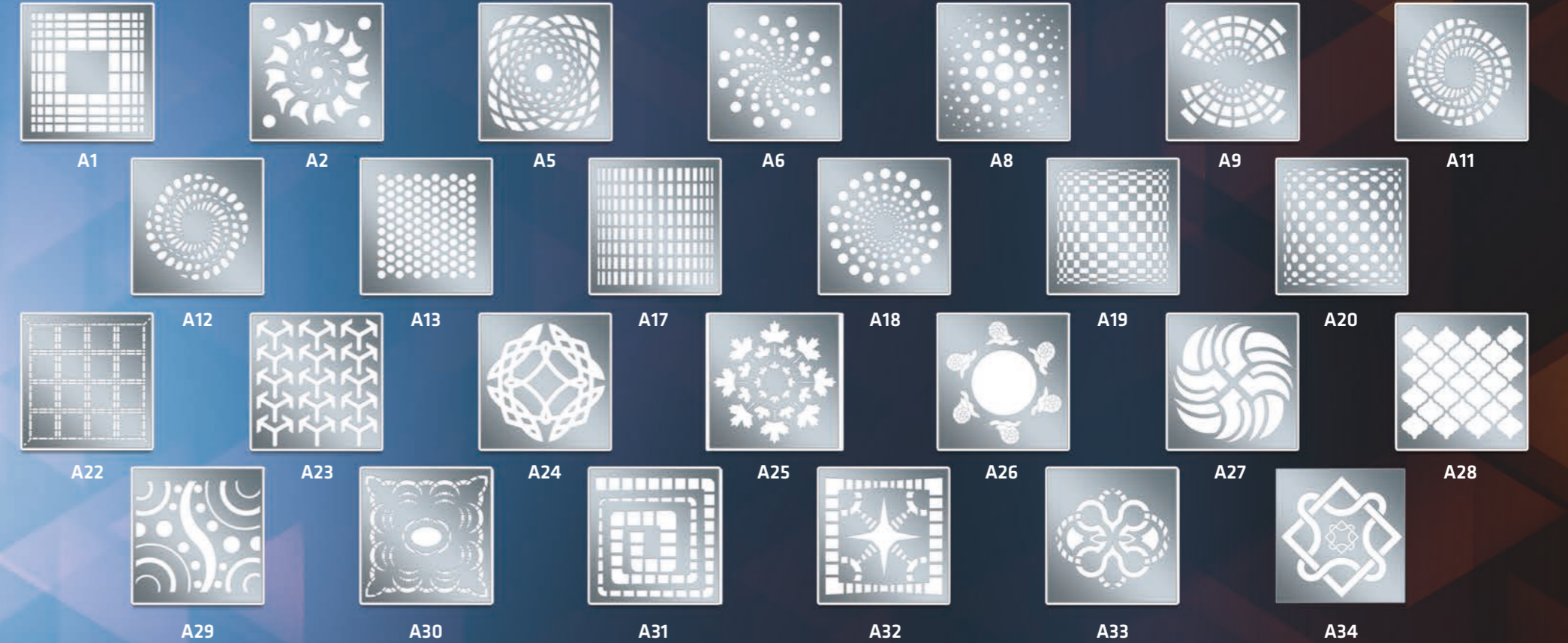

A1

A2

A5

A6

A8

A9

A11

A12

A13

A17

A18

A19

A20

A28

A22

A23

A24

A25

A26

A27

A28

A29

A30

A31

A32

A33

A34



Üst Bombeli  
Concave Up  
Haut-Cambre

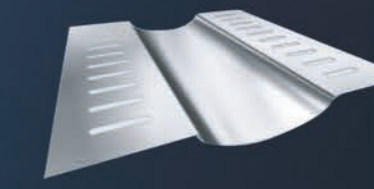

Alt Bombeli  
Convex Curved  
Sous-Cambre



Standart Tavan  
Standart Ceiling  
Plafond Standard

AKSESUARLAR  
ACCESSORIES | ACCESSORIES

## DUVAR DÖŞEME MALZEMELERİ

WALL COATING MATERIALS | MATERIALS DE REVETEMENT MURAL

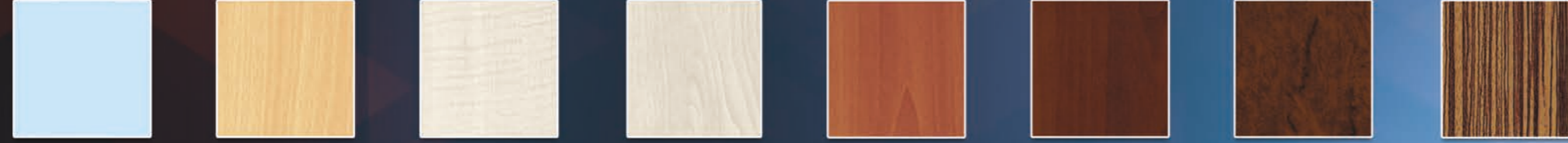

Gentaş 3133 Gentaş 4204 Gentaş 4206 Gentaş 4207 Gentaş 4214 Gentaş 4251 Gentaş 4253 Gentaş 4260

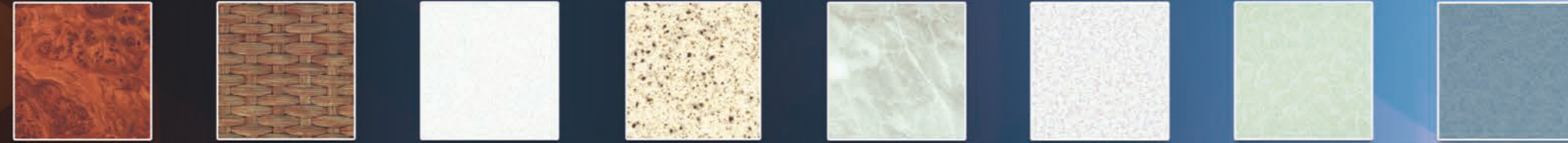

Gentaş 4267 Gentaş 4346 Gentaş 4496 Gentaş 5330 Gentaş 5414 Gentaş 5427 Gentaş 7295 Gentaş 7303

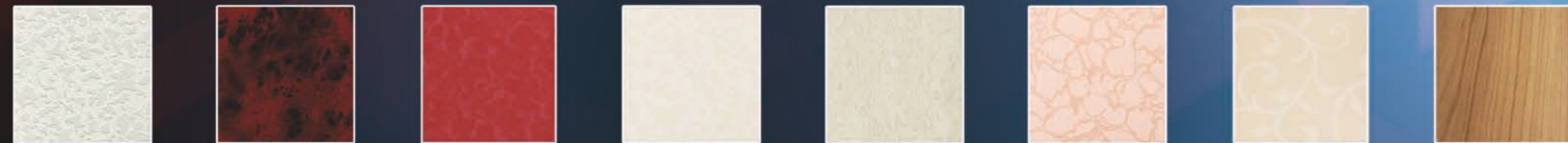

Arpa 0997 Arpa 1051 Arpa 3099 Arpa 3112 Arpa 3135 Arpa 3191 Arpa 3279 Arpa 3311

### Doğal Granit

Natural Granite | Granit Naturel

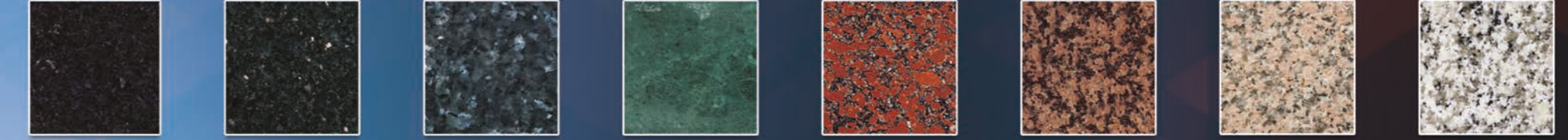

Nero Zimbabwe Star Galaxy Blue Pearl Verde Guatemala Santiago Red Carmen Red Rosa Porino Bianco Sardo

### Dekoratif PVC Karolar

Decorative PVC Tiles | PVC Carreaux Décoratifs



3714 ES-5 1341-6 1223

### PVC Kaplamalar

PVC Coatings | PVC Revêtements



Gri Gray Sarı Yellow Kahve Brown

### Metal Kaplamalar

Metal Coatings | Revêtements Métallique

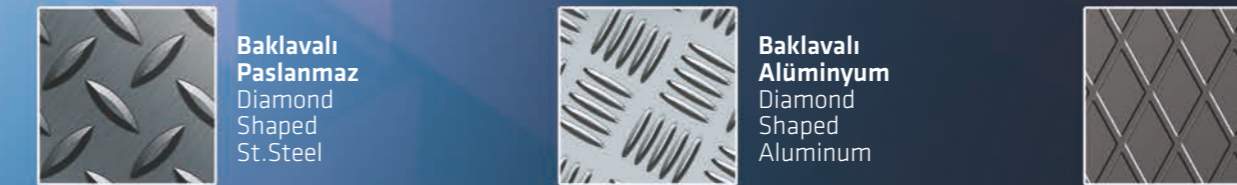

Baklavalı Paslanmaz  
Diamond Shaped  
St. Steel

Baklavalı Alüminyum  
Diamond Shaped  
Aluminum

Baklavalı Saç  
Diamond Shaped  
Sheet Steel

AKSESUARLAR

ACCESSORIES | ACCESSOIRES

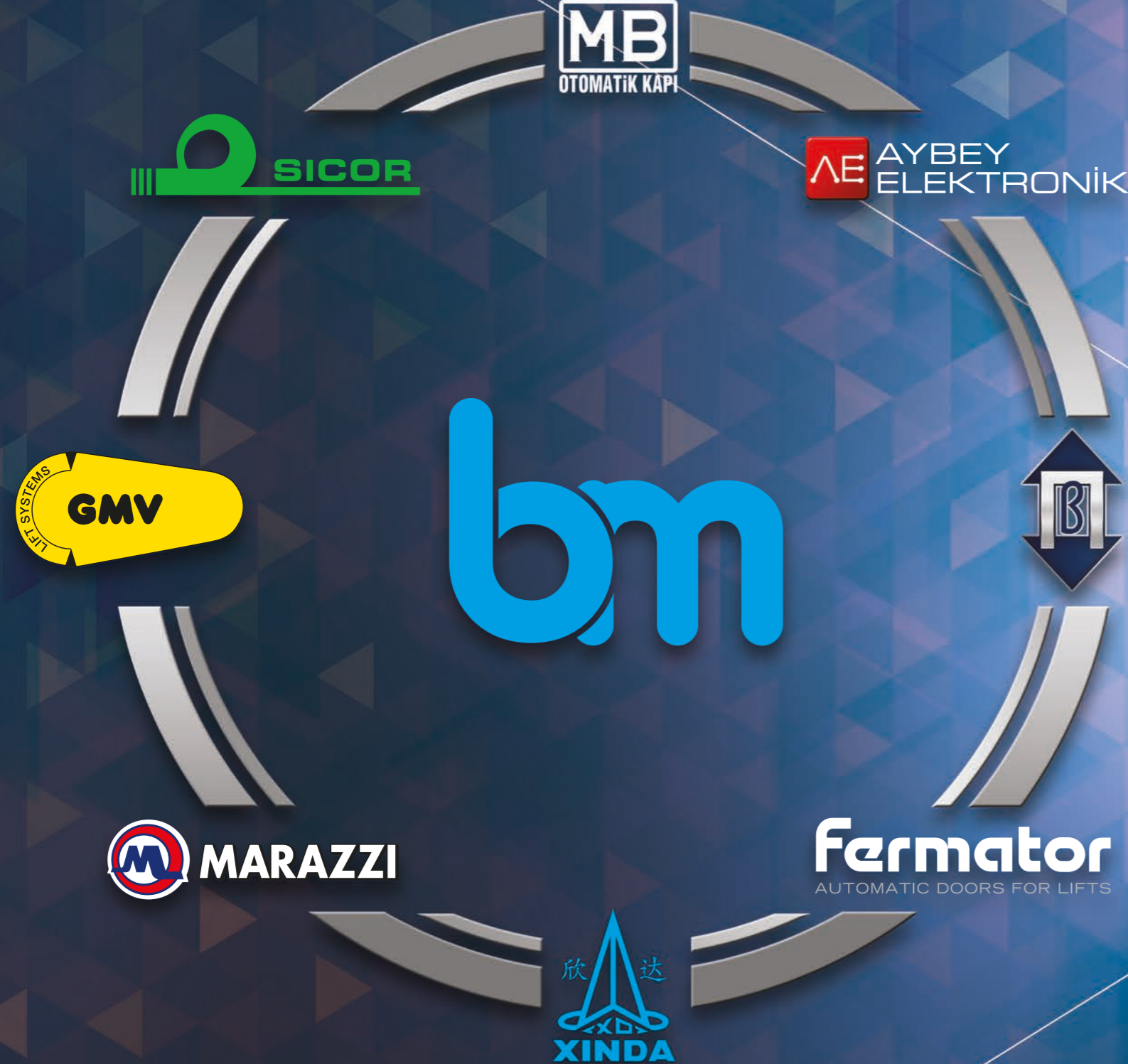

# DİSTRİBÜTÖRLÜKLER

DISTRIBUTORSHIPS / DISTRIBUTIONS



Türkiye  
Yetkili  
Distribütörü

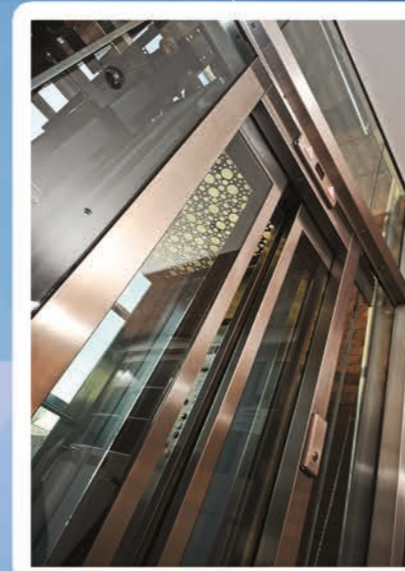

# Fermator

AUTOMATIC DOORS FOR LIFTS

Fermator, otomatik asansör kapıları üretiminde dünya çapındaki lider firmalardan biridir. Fermator, 1977'de Reus - İspanya'da başlayan otomatik kapı üretimine İspanya merkezli olarak Fransa, İtalya, Çin, Hindistan, Yunanistan, Brezilya, Polonya' daki üretim tesislerinde devam etmektedir. Bulut Makina, 1995'ten beri Fermator Otomatik Kapıları'nın Türkiye ana distribütörlüğünü yapmaktadır.

Fermator began lift door production in Reus, Spain in 1977. Fermator became one of the leading automatic door manufacturers in the world and has currently production plants in Spain, France, India, Greece, Italy, China, Poland, and Brazil. Bulut Makina is the main distributor of Fermator Automatic Doors since 1995.

Fermator, a commencé la production de porte d'ascenseur à Reus, Espagne en 1977. Fermator est devenu l'un des principaux fabricants des portes automatiques dans le monde et possède actuellement des usines de production en Espagne, France, Inde, Grèce, Italie, Chine, Pologne et le Brésil. Bulut Makina est le principal distributeur de Fermator Portes Automatiques de la Turquie depuis 1995.

OTOMATİK KAPI SİSTEMLERİ  
AUTOMATIC DOOR SYSTEMS | SYSTEMES DE PORTE AUTOMATIQUE

# Fermator

AUTOMATIC DOORS FOR LIFTS

*Türkiye  
Yetkili  
Distribütörü*

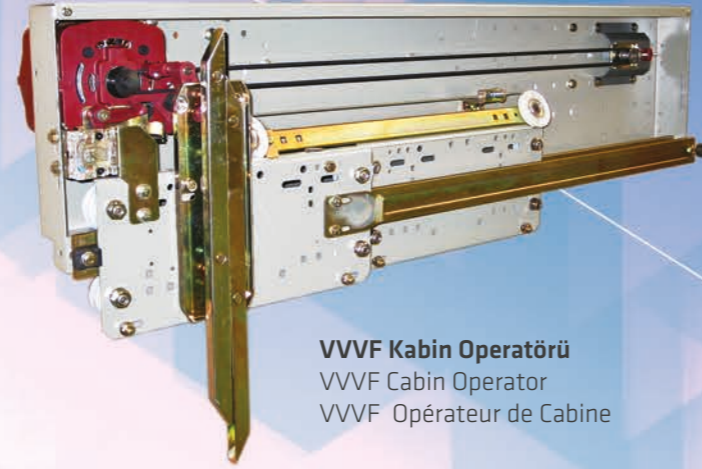

**VVF Kabin Operatörü**  
VVF Cabin Operator  
VVF Opérateur de Cabine



**50/11 Serisi**  
50/11 Series  
50/11 Série



**40/10 Serisi**  
40/10 Series  
40/10 Série



OTOMATİK KAPI SİSTEMLERİ  
AUTOMATIC DOOR SYSTEMS | SYSTEMES DE PORTE AUTOMATIQUE



GMV, 1958'de Milano - İtalya'da başlayan asansör sektörü macerasına dünyanın en fazla kullanılan asansör hidrolik ünitesi üreticisi olarak devam etmektedir. GMV, üretimini her aşamasında yüksek teknolojinin sunduğu olanaklardan faydalanmasının yanı sıra, modern asansör sektöründe var olan pek çok gereksinimi karşılayacak konumdadır. Emniyet, şıklık, çok yönlülük ve ergonomik kullanım avantajları, GMV'yi tasarımcılar ve montaj firmaları açısından en ideal çözüm yolu haline getirmektedir.

**Bulut Makina, 2000 yılından beri GMV Hydraulics firmasının tek yetkili Türkiye distribütörlüğünü yapmaktadır.**

GMV continues its way in lift sector as the first rank in lift hydraulics in the worldwide, which started in Milan - Italy factory in 1958. GMV benefits from the opportunities of high technology for each process of its manufacturing and also is in the position of meeting many requirements in modern lift sector. The advantages of safety, elegance, versatility and economical usage make GMV the most ideal solution for designers and installers.

Bulut Makina is solely Turkey distributor of GMV hydraulics since the year of 2000.

GMV continue son chemin dans le segment d'ascenseur commencé à Italie - Milano en 1958 comme le Producteur de l'unité hydraulique utilisée maximales sur le monde. GMV profite des opportunités de l'haute-technologie pour chaque processus de sa production et aussi, est dans la position de répondre à beaucoup des exigences dans le secteur modern d'ascenseur. Les avantages de sécurité, élégance, versatilité et usage économique devient GMV à la plus idéale solution pour designers et installateurs.

Bulut Makina est le distributeur exclusif en Turquie de GMV Hydrauliques depuis 2000.

*Türkiye  
TEK  
Yetkili  
Distribütörlüğü*



HİDROLİK ÜNİTE VE EKİPMANLARI  
HYDRAULIC UNITS AND EQUIPMENTS | UNITE HYDRAULIQUE ET EQUIPEMENTS



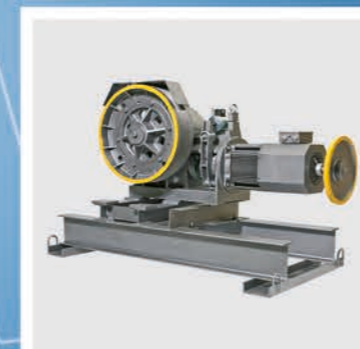
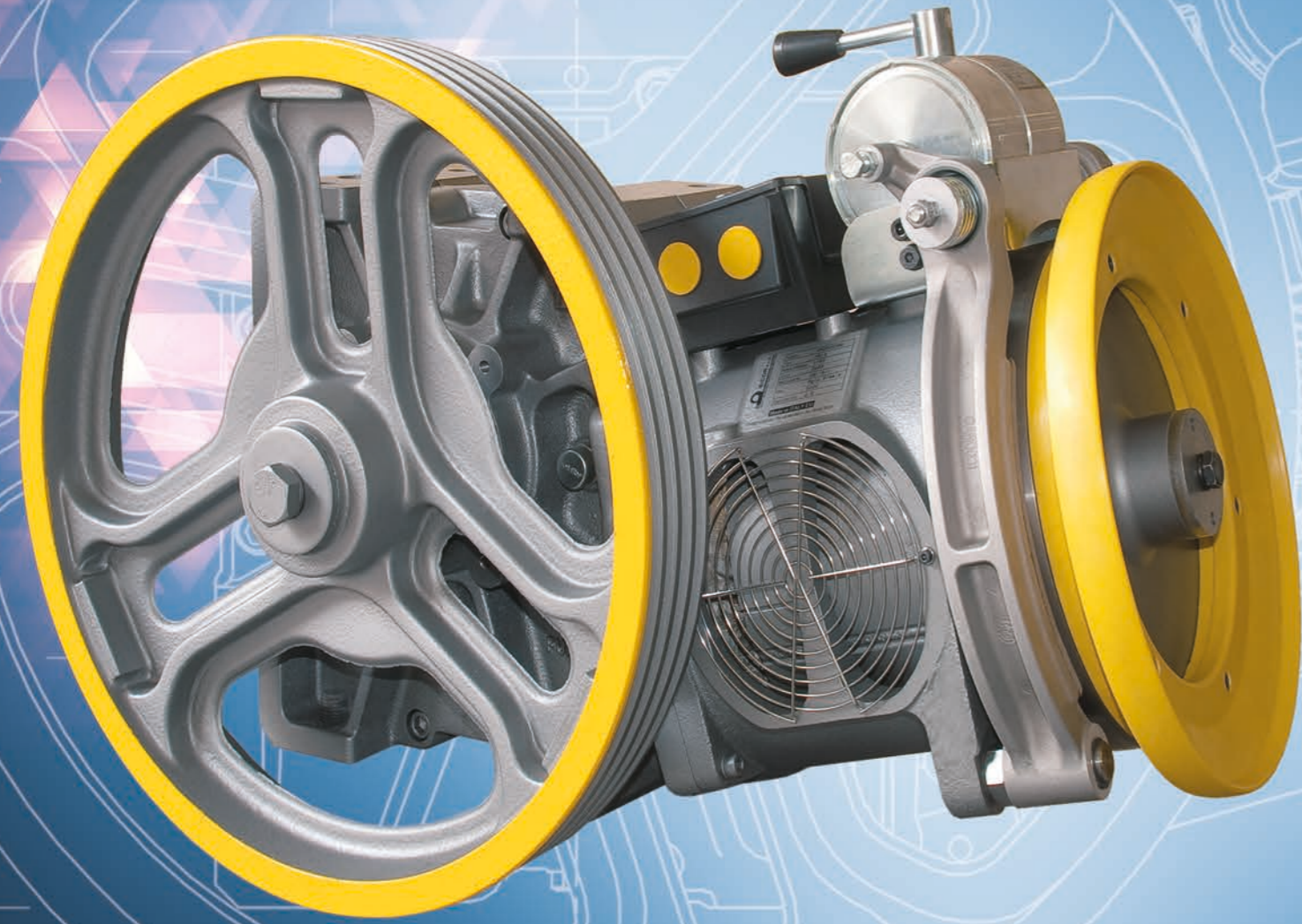

Türkiye  
**TEK**  
Yetkili  
Distribütörlüğü



1982'de asansör sektöründen bir grup girişimci tarafından, insan ve yük asansörleri için yüksek kaliteli asansör makineleri üretmek amacıyla kurulan Sicor S.p.A, Rovereto - İtalya'daki üretim tesisinde tüm sistemler için emniyeti sağlayan ve teknolojik çözümler sunan redüktörlü ve dişlisiz elektrikli asansör makine sistemleri üretmektedir.

**Bulut Makina, 2010 yılından itibaren Sicor Asansör Makineleri'nin Türkiye tek yetkili distribütörlüğünü yürütmektedir.**

Sicor S.p.A. founded with a precise mission to produce high quality elevator traction machines for persons and goods by a group of entrepreneurs in the elevator segment in 1982, manufactures a complete range of gears and gearless elevator traction systems presenting technologic solutions and ensuring the safety for all types of system at its production plant in Rovereto - Italy.

Bulut Makina is solely Turkey distributor of Sicor S.p.A. traction machines since the year of 2010.

Sicor S.p.A. étant fondé avec une mission précise pour produire les machines d'ascenseur avec haute qualité pour personnes et biens par un groupe des entrepreneurs dans le segment d'ascenseur en 1982, produit les systemes de machines électriques avec réducteur et sans réducteur présentant les solutions technologiques et assurant la sécurité aux tous les types de systeme dans la fabrique à Rovereto - Italie.

Bulut Makina est le distributeur exclusif en Turquie de Sicor machines d'ascenseur depuis 2010.

asansör makinası

LIFT MACHINE | MACHINE D'ASCENSEUR

## Soğuk Çekme Kılavuz Rayları

Cold Drawn Guide Rails / Rails de Guidage Etirés a Froid  
Çelik / Steel / Acier

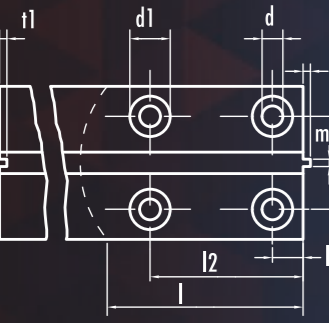
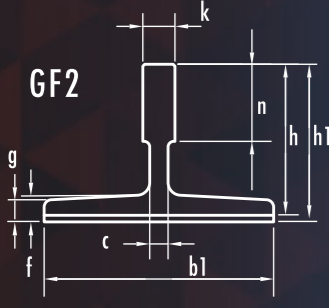
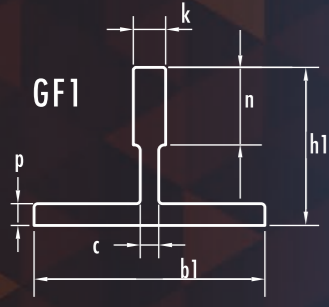

GF1	ISO 7465 ed.09/97	b1	h1	h	k	n	c	g	p	m1	m2	t1	t2	d	d1	l	b3	l2	l3
GF509	-	50	50	-	9	35	7,5	-	6,5	3	2,95	3,5	3	9	-	-	30	75	25
GF765	T 70-1/A	70	65	-	9	34	6	-	7	3	2,95	3,5	3	13	-	128	42	105	25
GF770	-	70	70	-	9	35	8	-	8,5	3	2,95	3,5	3	13	-	123	43	90	30
GF762	T 75-3/A	75	62	-	10	30	8	-	7,5	3	2,95	3,5	3	13	-	123	43	90	30

GF2	ISO 7465 ed.09/97	b1	h1	h	k	n	c	g	f	m1	m2	t1	t2	d	d1	l	b3	l2	l3
GF654	-	65	54	-	8	20	5	4	6	2	1,95	2,5	2	11	-	-	38	75	25
GF829	T 82/A	82,5	68,25	-	9	25,4	7,5	6	8,25	3	2,95	3,5	3	13	26*	111	50,8	81	27
GF890	T 89/A	89	62	61*	15,88	33,4	10	7,9	11,1	6,4	6,37	7,14	6,35	13	26*	156	79,4	114,3	38,1
GF975	T 90/A	90	75	74*	16	42	10	8	10	6,4	6,37	7,14	6,35	13	26*	156	79,4	114,3	38,1
GF125	T 125/A	125	82	81*	16	42	10	9	12	6,4	6,37	7,14	6,35	17	33*	156	79,4	114,3	38,1

İtalya'da asansör rayları odaklı olarak kurulan ilk firmalardan olan ve 40 yılı aşkın süredir asansör sektörüne hizmet veren Marazzi S.r.l., 1197'de UNI EN ISO 9002:1994 kalite sertifikası ve 2008'de yenilenen UNI EN ISO 9001:2008 kalite sertifikalarının sahibidir.

Bulut Makina, 2013 yılı itibarıyla Marazzi Asansör Rayları'nın Türkiye tek yetkili distribütörlüğünü yapmaktadır.

Marazzi S.r.l., being the one of companies founded with a strong focus on the segment of the lifts guide rails and giving service in the lift sector for forty years, has the UNI EN ISO 9002:1994 quality certification in 1997 and the quality certification to the new standard UNI EN ISO 9001:2008 in 2008.

Bulut Makina is solely Turkey distributor of Marazzi S.r.l. Guide rails since the year of 2013.

Marazzi S.r.l., étant l'un des sociétés premiers fondées avec une concentration forte sur le segment des rails de guidage pour ascenseurs et servant dans le secteur d'ascenseur pendant quarante ans, possède le certificate de qualité UNI EN ISO 9002:1994 en 1997 et le certificate de qualité accordant avec standard nouveau UNI EN ISO 9001:2008 en 2008.

Bulut Makina est le distributeur exclusif en Turquie de Marazzi rails de guidage d'ascenseur depuis 2013.

Türkiye  
**TEK**  
Yetkili  
Distribütörlüğü

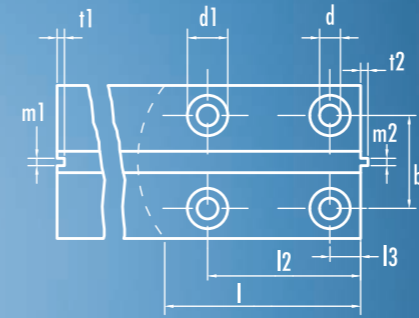
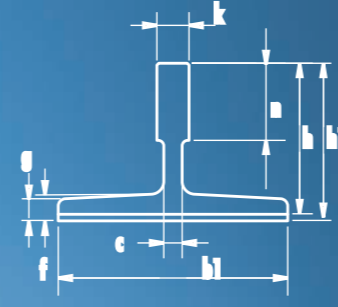

## İşlenmiş Kılavuz Rayları

Machined Guide Rails / Rails de Guidage Usinés  
Çelik / Steel / Acier

GM	ISO 7465 ed.09/97	b1	h1	h	k	n	c	g	f	m1	m2	t1	t2	d	d1	l	b3	l2	l3
GM890	T 89/B	89	62	61	15,88	33,4	10	7,9	11,1	6,4	6,37	7,14	6,35	13	26	156	79,4	114,3	38,1
GM975	T 90/B	90	75	74	16	42	10	8	10	6,4	6,37	7,14	6,35	13	26	156	79,4	114,3	38,1
GM125	T 125/B	125	82	81	16	42	10	9	12	6,4	6,37	7,14	6,35	17	33	156	79,4	114,3	38,1
GM127-1	T 127-1/B	127	88,9	88	15,88	44,5	10	7,9	11,1	6,4	6,37	7,14	6,35	17	33	156	79,4	114,3	38,1
GM127-2	T 127-2/B	127	88,9	88	15,88	50,8	10	12,7	15,9	6,4	6,37	7,14	6,35	17	33	156	79,4	114,3	38,1
GM127-3	-	127	88,9	88	15,88	50,8	14	12,7	15,9	6,4	6,37	7,14	6,35	17	33	156	79,4	114,3	38,1
GM140-1	T 140-1/B	140	108	107	19	50,8	12,7	12,7	15,9	6,4	6,37	7,14	6,35	21	40	193	92,1	152,4	31,8
GM140-2	T 140-2/B	140	102	101	28,6	50,8	17,5	14,5	17,5	6,4	6,37	7,14	6,35	21	40	193	92,1	152,4	31,8

## Yüksek Kalitede İşlenmiş Kılavuz Rayları

High Quality Machined Guide Rails / Rails de Guidage Usinés avec Haute-technologie  
Çelik / Steel / Acier

GE	ISO 7465 ed.09/97	b1	h1	h	k	n	c	g	f	m1	m2	t1	t2	d	d1	l	b3	l2	l3
GE125	T 125/BE	125	82	81	16	42	10	9	12	6,4	6,37	7,14	6,35	17	33	156	79,4	114,3	38,1
GE127-1	T 127-1/BE	127	88,9	88	15,88	44,5	10	7,9	11,1	6,4	6,37	7,14	6,35	17	33	156	79,4	114,3	38,1
GE127-2	T 127-2/BE	127	88,9	88	15,88	50,8	10	12,7	15,9	6,4	6,37	7,14	6,35	17	33	156	79,4	114,3	38,1
GE127-3	-	127	88,9	88	15,88	50,8	14	12,7	15,9	6,4	6,37	7,14	6,35	17	33	156	79,4	114,3	38,1
GE140-1	T 140-1/BE	140	108	107	19	50,8	12,7	12,7	15,9	6,4	6,37	7,14	6,35	21	40	193	92,1	152,4	31,8
GE140-2	T 140-2/BE	140	102	101	28,6	50,8	17,5	14,5	17,5	6,4	6,37	7,14	6,35	21	40	193	92,1	152,4	31,8

## Yüksek Hızlı Asansörler için (> 2 mt/sn)

For High Speed Elevator (> 2 mt/sec) / Pour Ascenseurs à Grande Vitesse (> 2 mt/sec)

GE kılavuz rayları ISO7465 standardı "Yüksek Kaliteyle İşlenmiş Kılavuz rayları" BE sınıfına uygundur. Konfor hissini artırmak ve sessiz hareket garantisi verebilmek adına özellikle ray uçlarının işlenmesinde (h,k,m1,m2 ve ray ağız ile ray kızıağı) ve ray hareketinin düzenlenmesinde sık toleranslar gerekmektedir.

GE guide rails are in accordance with ISO7465 Class BE "High Quality Machined Guide Rails". In order to increase the comfort and guarantee silent moving, tight tolerances are required especially in machining of ends (h, k, m1, m2 and centering of key and keyway) and straightening operations.

GE rails de guidage sont conformément à ISO7465 Classe BE "Rails de guidage usiné avec haute-technologie". Afin d'augmenter le confort et de garantir le mouvement silencieux, les tolérances serrées sont nécessaires dans notamment l'usinage des fins (h, k, m1, m2 et bosse de rail et son voie) et dans l'amélioration des opérations.

# ASANSÖR KILAVUZ RAYLARI

LIFT GUIDE RAILS | RAILS DE GUIDAGE D'ASCENSEUR

- 1975 yılından beri hızla büyümesini sürdüren Xinda, 1995 yılında da yürüyen merdiven üzerine Çin'in ilk motorlarını geliştirdi. 2000 yılında, şu anda yaygınca kullanılan dişlisiz makine modelini geliştirerek ülke içerisinde çeşitli ödüller almaya hak kazandı.  
-Xinda yüksek kalitede ve sağlamlıkta dişlisiz makinalar üretmektedir. Özellikle 800 ve 1000kg uygulamalarda 40cm ve üzeri tahrik kasnağı kullanılmasından dolayı, kendir özlü halata uygunluğu sayesinde makinanın iddialı fiyatı toplamda daha rekabetçi olmaktadır.  
- 9 yıl peş peşe müşteri memnuniyeti ve satış sonrası hizmetleri ödülünü kazanan Xinda, Bulut Makina ve Aybey Elektronik'in tecrübesiyle kullanıcılarının memnuniyetini ülkemizde de üst düzeyde tutmaktadır.

- Xinda, which has been growing rapidly since 1975, developed China's first machines for escalator in 1995. In 2000, Xinda developed a model of gearless machine, which is now widely used, and is earned several awards in his own country.  
-Xinda manufactures gearless machines in high quality and robustness. Especially machines for 800kg and 1000kg applications, for which 40cm or higher pulleys, with standart fibre core ropes compatibility ensures the competitiveness of Xinda, alongside its reasonable prices.  
- Xinda, which has won customer satisfaction and after-sale service awards for 9 consecutive years, aims to keep the customer satisfaction at the highest level in our country through the experiences of Bulut Makina and Aybey Elektronik.

- Xinda, qui a connu une croissance rapide depuis 1975, a développé la première machine d'escalier roulant Chinois en 1995. en 2000, Xinda a développé un Modèle pour la machine Gearless qui est aujourd'hui largement utilisé, et a reçu plusieurs prix dans son propre pays  
- Xinda produit les machines Gearless de haute qualité et robustesse, et spécialement les machines pour les applications de 800 et 1000 Kg, dont la compatibilité des poulies de 40 cm ou plus, avec les âmes en fibre standards, peuvent devenir en total plus compétitifs  
- Xinda qui a remporté le prix de la satisfaction client et le prix du meilleur service après vente 9 fois consécutives, maintient la satisfaction de ses utilisateurs au plus haut niveau dans notre pays grâce à l'expérience de Bulut Makina et Aybey Elektronik.

asansör makinası

LIFT machine | machine d'ascenseur

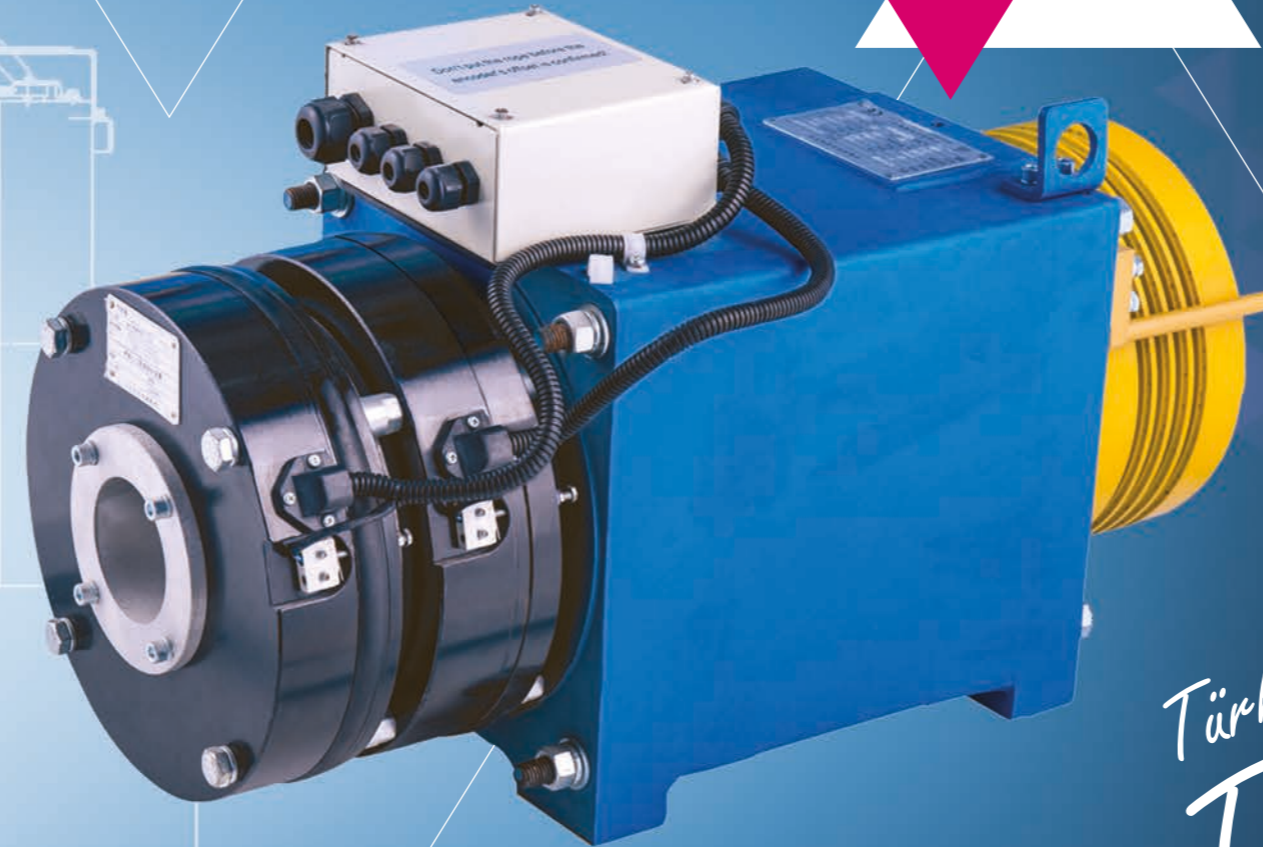
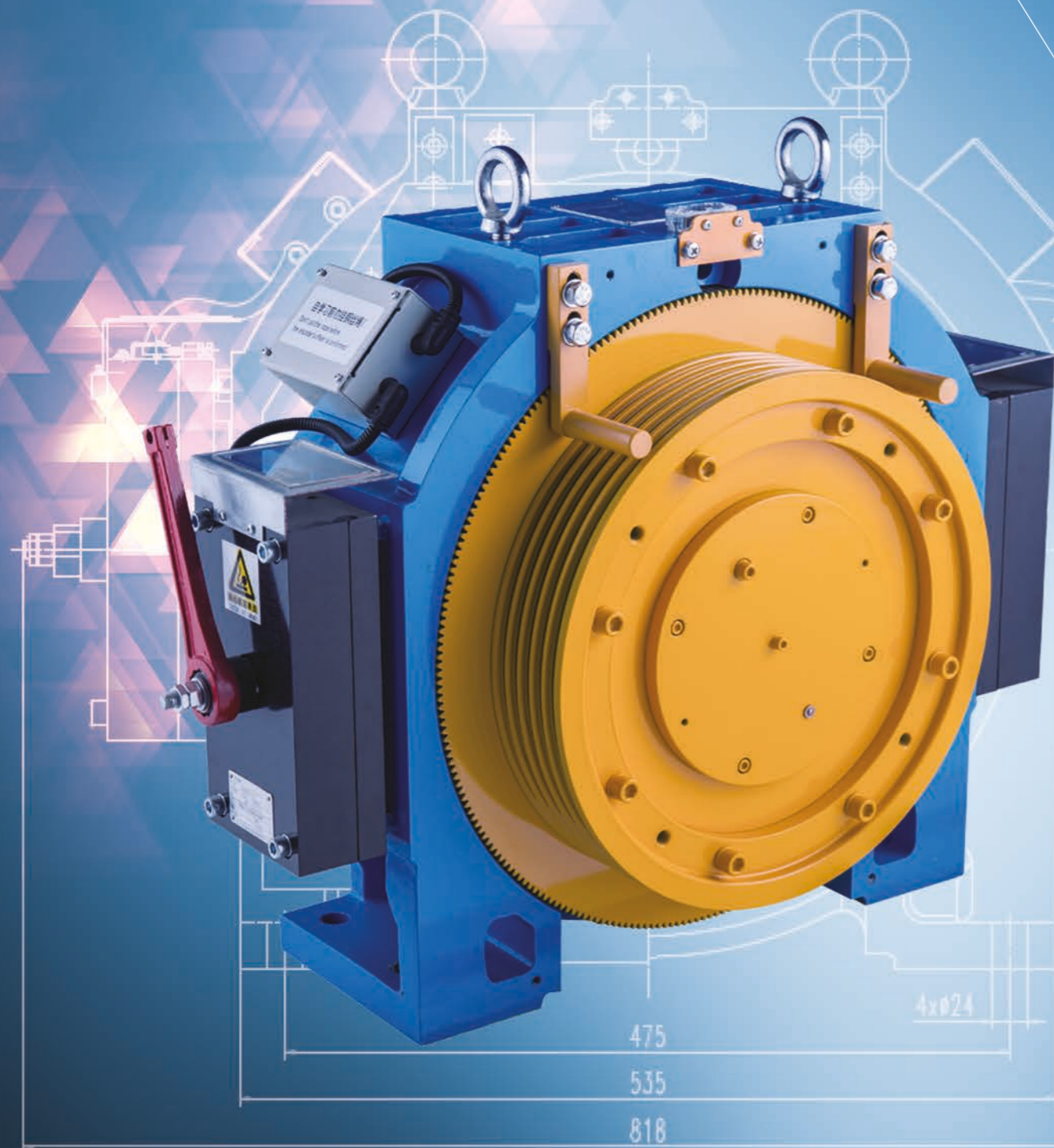

Türkiye  
TEK  
Yetkili  
Distribütörlüğü

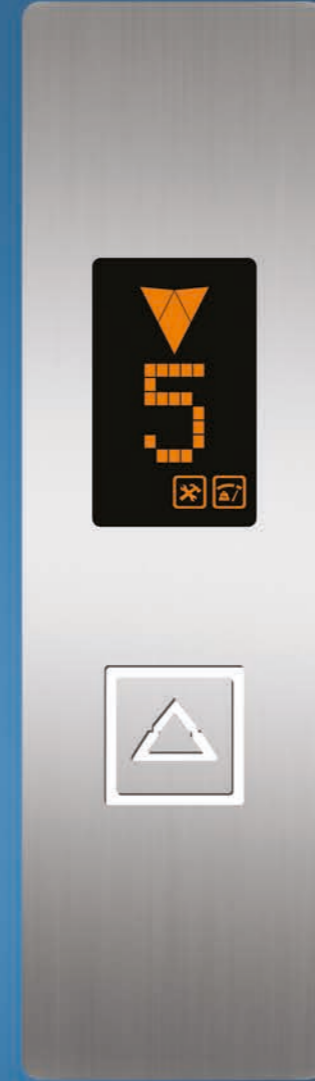
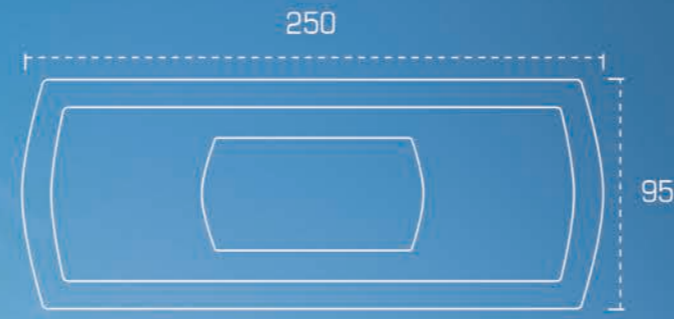

2000



**AE AYBEY ELEKTRONİK**  
*Asansöre hayat veriyoruz...*

BUTON VE GÖSTERGE SİSTEMLERİ

BUTTON AND DISPLAY SYSTEMS | SYSTEMES DE BOUTON ET D'INDICATEUR

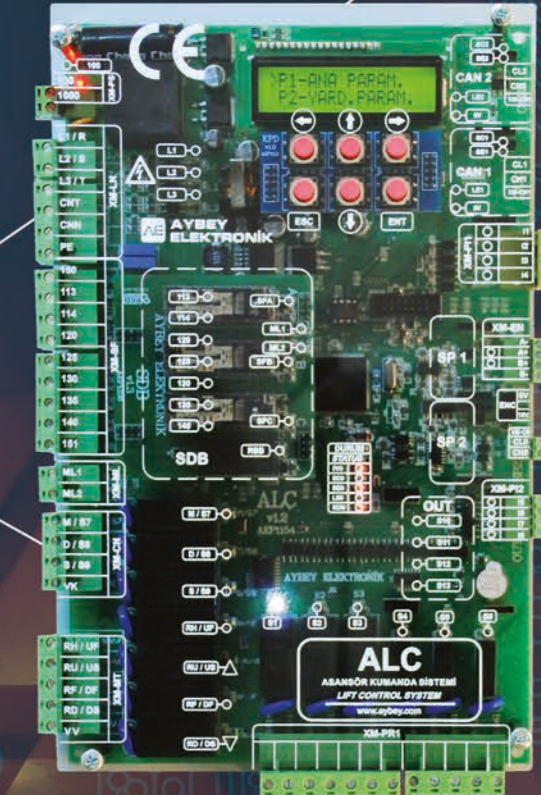
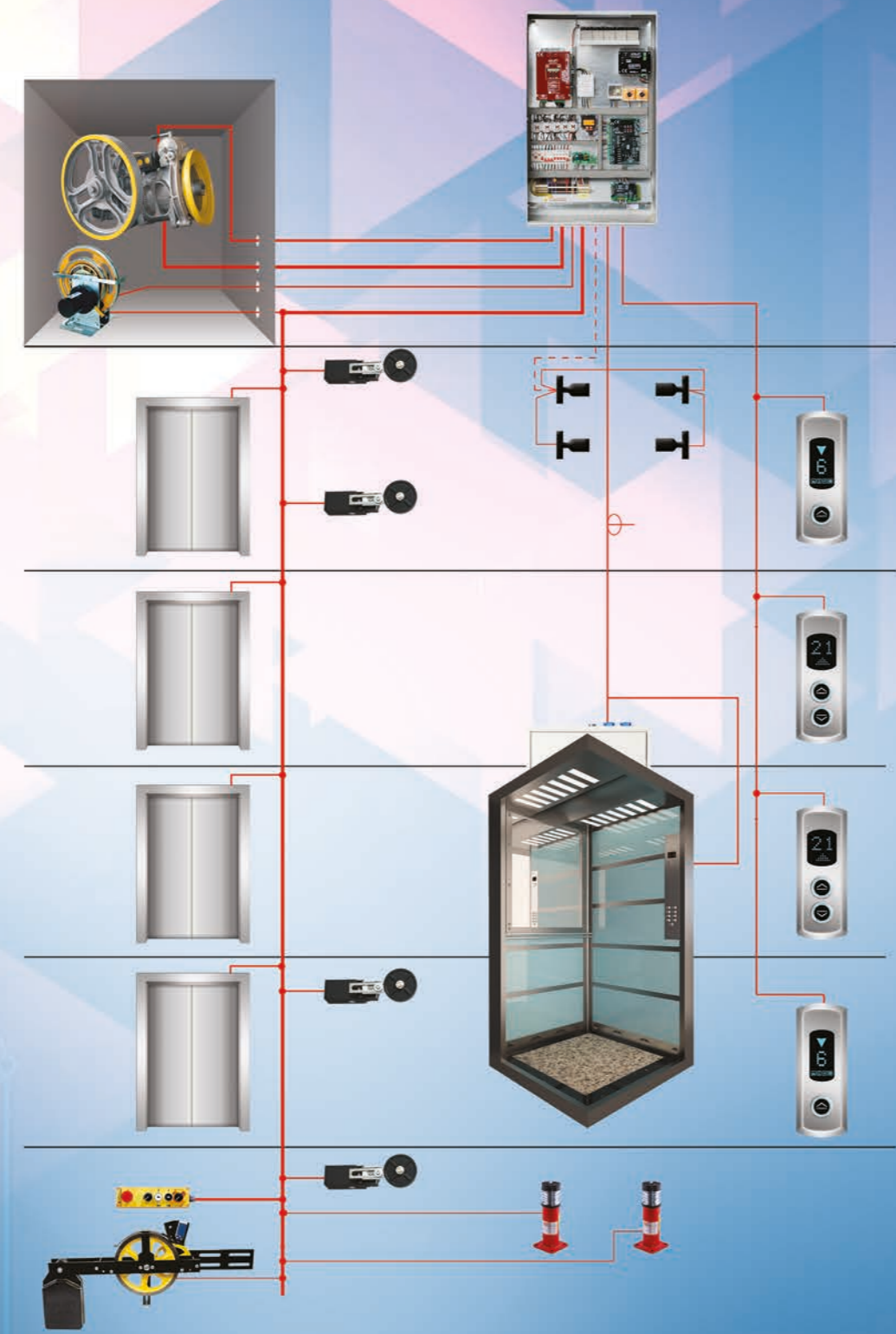
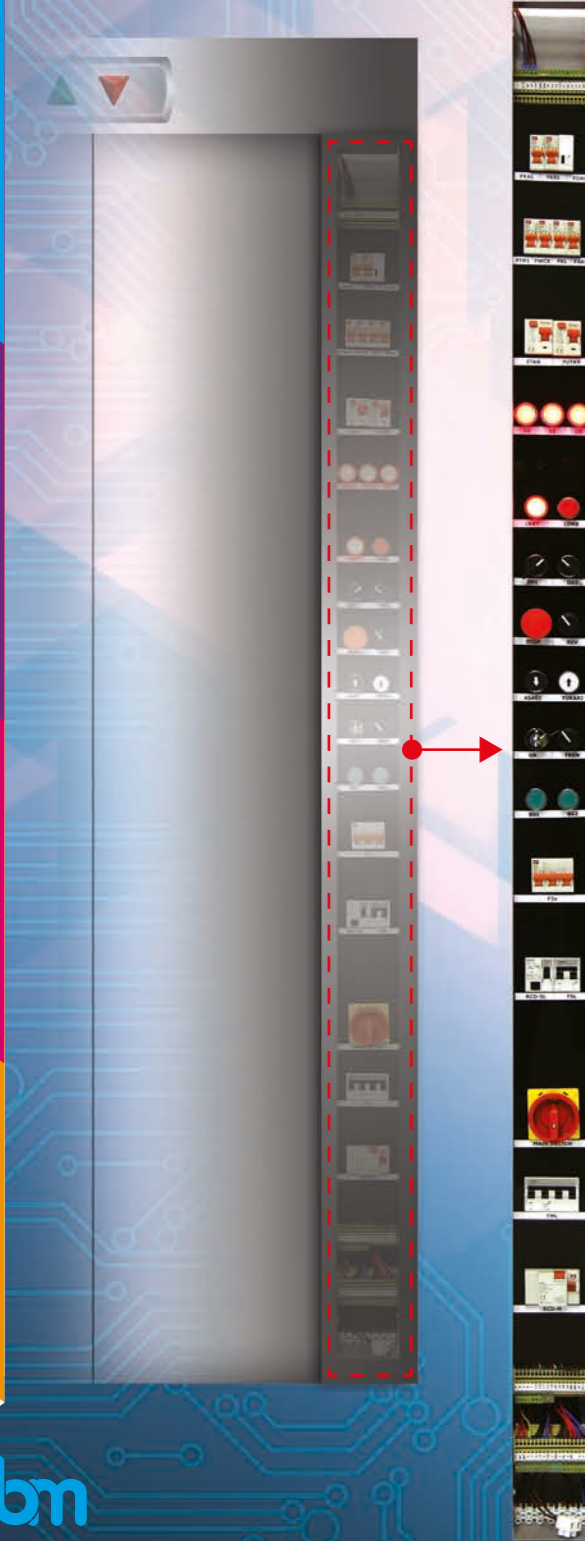

**AE AYBEY ELEKTRONİK**  
*Asansöre hayat veriyoruz...*

asansör kontrol sistemleri  
LIFT CONTROL SYSTEMS | SYSTEMES DE CONTROLE D'ASCENSEUR



## Asansöre dair her şey...

Bulut Makina, uzun yıllara dayanan tecrübesiyle; dünyanın ve Türkiye'nin kendi sektöründe lider olan markaları ve hem yurtiçi hem de yurtdışı tanınan geniş üretim yelpazesıyla tüm müşterilerine ihtiyaçlarına uygun özel çözümler sunmakta ve müşterilerinin A dan Z ye tüm ihtiyacının Bulut Makina paket asansörleriyle tek bir noktadan karşılanmasını sağlamaktadır.

Bulut Makina, offers customized products that are being produced according to the customer requirements and provides solutions for all of those necessary requirements for complete lift packages, through its long-term experience in the industry. Moreover, a wide range of both domestic and globally-known branded products are also being supplied by Bulut Makina.

Bulut Makina , propose des produits personnalisés qui sont produites selon les exigences du client et fournit des solutions pour l'ensemble de ceux exigences nécessaires pour les paquets de ascenseur complètes , à travers sa longue expérience dans l'industrie . En outre , une large gamme de produits nationaux et à l'échelle mondiale connues des marques sont également fournies par Bulut Makina.

Batı ve Doğu

# Avrupa

# Ortadoğu

# Balkanlar

# Asya

# Afrika

West Europe

East Europe

Balkans

Middle East

Asia

Africa

Ouest-Europe

Est-Europe

Balkans

Moyen Orient

Asie

Afrique



İHRACAT ALANLARIMIZ

EXPORT AREAS | REGIONS D'EXPORT



**ASANSÖR SEKTÖRÜNDE KALİTE ve GÜVEN**  
 Your Reliable Partner for Lift Solutions  
 Votre Partenaire Fiable pour les Solutions d'Ascenseurs