

Asansöre dair her şey...

Bulut Makina, uzun yıllara dayana tecrübesiyle müşterilerinin ihtiyaçlarına uygun çözümler sunmakta ve onların A'dan Z'ye tüm ihtiyacını paket asansör sistemleriyle tek bir noktadan karşılamaktadır. Ayrıca dünyada ve Türkiye'de kendi sektöründe lider markaların ürünlerini de tedarik etmektedir.

Bulut Makina, offers complete range of lift components as well as complete packages according to the needs of the customers and provides specific solutions to their requirements through its long-term experience in lift industry. A wide range of domestic and globally-known branded products are supplied by Bulut Makina.

Forte d'une longue expérience dans ce domaine, la société Bulut Makina, offre des produits personnalisés répondant aux besoins spécifique de ses clients et fournit des solutions qui répondent aux exigences des clients en matière d'ascenseur complet. En outre, une large gamme de produit de marque connue a l'échelle national et International sont fournie par la société Bulut Makina.



bm bulut makina

Orhanlı Mh. Katip Çelebi Cd. N:17 34956 Tuzla - İstanbul / TÜRKİYE
T: +90 (216) 394 50 50 (pbx) F: + 90 216 394 50 54 E: sales@bulutmakina.com

www.bulutmakina.com



DİSTRİBÜTÖRLÜKLER
DISTRIBUTORSHIPS / DISTRIBUTIONS

Fermator

AUTOMATIC DOORS FOR LIFTS

Fermator, otomatik asansör kapıları üretiminde dünya çapındaki lider firmalardan biridir. Fermator, 1977'de Reus - İspanya'da başlayan otomatik kapı üretimine İspanya merkezli olarak Fransa, İtalya, Çin, Hindistan, Yunanistan, Brezilya, Polonya' daki üretim tesislerinde devam etmektedir. Bulut Makina, 1995'ten beri Fermator Otomatik Kapıları'nın Türkiye ana distribütörlüğünü yapmaktadır.

Fermator began lift door production in Reus, Spain in 1977. Fermator became one of the leading automatic door manufacturers in the world and has currently production plants in Spain, France, India, Greece, Italy, China, Poland, and Brazil. Bulut Makina is the main distributor of Fermator Automatic Doors since 1995.

Fermator a commencé la production des portes d'ascenseur à Reus en Espagne en 1977, Fermator est devenue le leader en matière de production des portes automatique dans le monde et possède actuellement des usines de production en Espagne, en France, en Inde, en Grèce, en Italie, en Chine, en Pologne et au Brésil. Bulut Makina est le principal Distributeur des Portes Automatique de Fermator en Turquie depuis 1995.

OTOMATİK KAPI SİSTEMLERİ

AUTOMATIC DOOR SYSTEMS | SYSTEMES DE PORTE AUTOMATIQUE

2CO + 50

CO

Türkiye
Yetkili
Distribütörü

OTOMATİK KAPI SİSTEMLERİ

AUTOMATIC DOOR SYSTEMS | SYSTEMES DE PORTE AUTOMATIQUE

Fermator

AUTOMATIC DOORS FOR LIFTS



VVF 50/11 Kabin Operatörü
VVF 50/11 Car Door Operator
VVF 50/11 Opérateurs de Porte Cabine



Elite MR PM Kabin Operatörü
Elite MR PM Car Door Operator
Elite MR PM Opérateurs de Porte Cabine



Elite MR Kat Mekanizması
Elite MR Landing Door Mechanism
Elite MR Mécanismes de Porte Palière

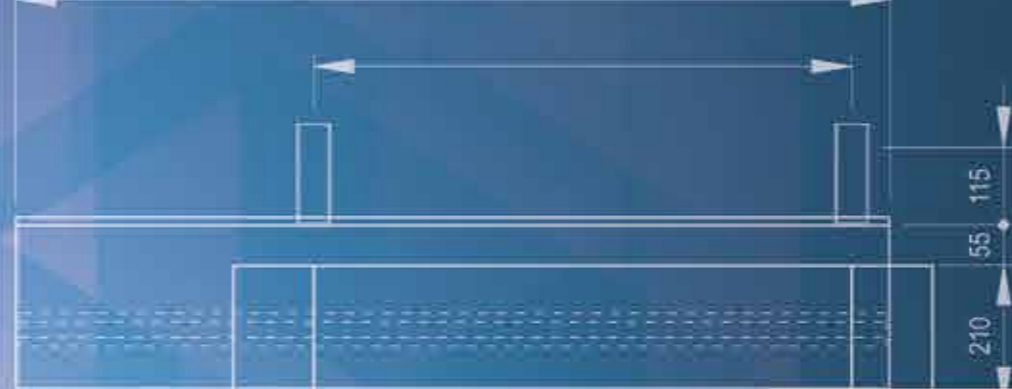

OTOMATİK KAPI SİSTEMLERİ
AUTOMATIC DOOR SYSTEMS | SYSTEMES DE PORTE AUTOMATIQUE



OTOMATİK KAPI SİSTEMLERİ
AUTOMATIC DOOR SYSTEMS | SYSTEMES DE PORTE AUTOMATIQUE

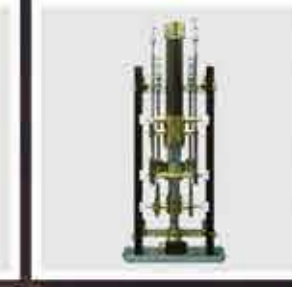
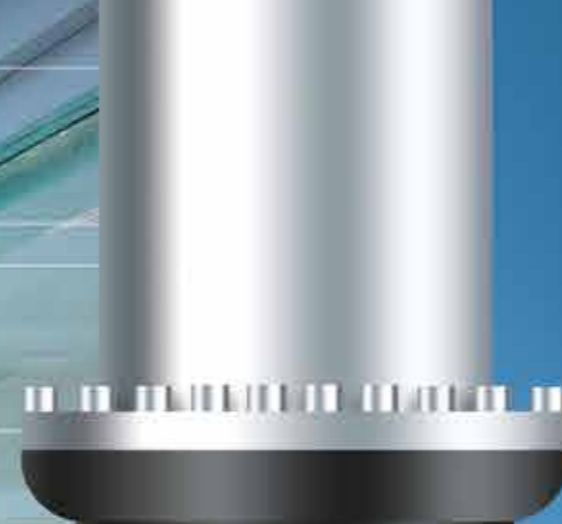

GMV, 1958'de Milano - İtalya'da başlayan asansör sektörü macerasına dünyanın en fazla kullanılan asansör hidrolik ünitesi üreticisi olarak devam etmektedir. GMV, üretimini her aşamasında yüksek teknolojinin sunduğu olanaklardan faydalanmasının yanı sıra, modern asansör sektöründe var olan pek çok gereksinimi karşılayacak konumdadır. Emniyet, şıklık, çok yönlülük ve ergonomik kullanım avantajları, GMV'yi tasarımcılar ve montaj firmaları açısından en ideal çözüm yolu haline getirmektedir.

Bulut Makina, 2000 yılından beri GMV Hydraulics firmasının tek yetkili Türkiye distribütörlüğünü yapmaktadır.

GMV continues its way in lift sector as the first rank in lift hydraulics in the worldwide, which started in Milan - Italy factory in 1958. GMV benefits from the opportunities of high technology for each process of its manufacturing and also is in the position of meeting many requirements in modern lift sector. The advantages of safety, elegance, versatility and economical usage make GMV the most ideal solution for designers and installers.

Bulut Makina is solely Turkey distributor of GMV hydraulics since the year of 2000.

GMV a commencé son aventure dans l'industrie des ascenseurs en 1958 à Milan en Italie, et poursuit aujourd'hui son ascension dans le secteur des ascenseurs en tant que premier producteur d'ascenseurs Hydraulique dans le monde. GMV possède une capacité d'offrir une haute technologie à chaque étape de production et est également en mesure de répondre à de nombreuses exigences dans le secteur des ascenseurs moderne. La sécurité, l'élégance, la polyvalence et l'ergonomie, font de GMV la solution idéale pour les concepteurs et les Sociétés d'installation

Bulut Makina est le seul distributeur en Turquie de GMV hydraulique depuis 2000

*Türkiye
TEK
Yetkili
Distribütörlüğü*



HİDROLİK ÜNİTE VE EKİPMANLARI

HYDRAULIC UNITS AND EQUIPMENTS | UNITE HYDRAULIQUE ET EQUIPEMENTS



HİDROLİK ÜNİTE VE EKİPMANLARI

HYDRAULIC UNITS AND EQUIPMENTS | UNITE HYDRAULIQUE ET EQUIPEMENTS



ASANSÖR MAKİNASI

LIFT MACHINE | MACHINE D'ASCENSEUR



Türkiye
TEK
Yetkili
Distribütörlüğü



1982'de asansör sektöründen bir grup girişimci tarafından, insan ve yük asansörleri için yüksek kaliteli asansör makineleri üretmek amacıyla kurulan Sicor S.p.A, Rovereto - İtalya'daki üretim tesisinde tüm sistemler için emniyeti sağlayan ve teknolojik çözümler sunan redüktörlü ve dişlisiz elektrikli asansör makine sistemleri üretmektedir.

Bulut Makina, 2010 yılından itibaren Sicor Asansör Makineleri'nin Türkiye tek yetkili distribütörlüğünü yürütmektedir.

Sicor S.p.A. founded with a precise mission to produce high quality elevator traction machines for persons and goods by a group of entrepreneurs in the elevator segment in 1982, manufactures a complete range of gears and gearless elevator traction systems presenting technologic solutions and ensuring the safety for all types of system at its production plant in Rovereto - Italy.

Bulut Makina is solely Turkey distributor of Sicor S.p.A. traction machines since the year of 2010.

Sicor S.p.a a été fondée pour une mission précise: produire des machines de bonne qualité pour les ascenseurs de personnes et de Marchandises. Un Groupe d'entrepreneurs dans le secteur des Ascenseurs décide en 1982, dans leur usine de production à Rovereto en Italie, de produire une gamme complète de système d'ascenseur Geared et Gearless tout en offrant des solutions technologiques en plus d'assurer la sécurité pour tout types de système

Bulut Makina est l'unique Distributeur de Sicor S.P.A en Turquie depuis 2010

ASANSÖR MAKİNASI

LIFT MACHINE | MACHINE D'ASCENSEUR

Soğuk Çekme Kılavuz Rayları

Cold Drawn Guide Rails / Rails de Guidage Etirés à Froid
Çelik / Steel / Acier

GF1	ISO 7465 ed.09/97	b1	h1	h	k	n	c	g	p	m1	m2	t1	t2	d	d1	l	b3	l2	l3
GF509	-	50	50	-	9	35	7,5	-	6,5	3	2,95	3,5	3	9	-	-	30	75	25
GF765	T 70-1/A	70	65	-	9	34	6	-	7	3	2,95	3,5	3	13	-	128	42	105	25
GF770	-	70	70	-	9	35	8	-	8,5	3	2,95	3,5	3	13	-	123	43	90	30
GF762	T 75-3/A	75	62	-	10	30	8	-	7,5	3	2,95	3,5	3	13	-	123	43	90	30

GF2	ISO 7465 ed.09/97	b1	h1	h	k	n	c	g	f	m1	m2	t1	t2	d	d1	l	b3	l2	l3
GF654	-	65	54	-	8	20	5	4	6	2	1,95	2,5	2	11	-	-	38	75	25
GF829	T 82/A	82,5	68,25	-	9	25,4	7,5	6	8,25	3	2,95	3,5	3	13	26*	111	50,8	81	27
GF890	T 89/A	89	62	61*	15,88	33,4	10	7,9	11,1	6,4	6,37	7,14	6,35	13	26*	156	57,2	114,3	38,1
GF975	T 90/A	90	75	74*	16	42	10	8	10	6,4	6,37	7,14	6,35	13	26*	156	57,2	114,3	38,1
GF125	T 125/A	125	82	81*	16	42	10	9	12	6,4	6,37	7,14	6,35	17	33*	156	79,4	114,3	38,1

İtalya'da asansör rayları odaklı olarak kurulan ilk firmalardan olan ve 40 yılı aşkın süredir asansör sektörüne hizmet veren Marazzi S.r.l, 1997'de UNI EN ISO 9002:1994 kalite sertifikası ve 2008'de yenilenen UNI EN ISO 9001:2008 kalite sertifikalarının sahibidir.

Bulut Makina, 2013 yılı itibarıyla Marazzi Asansör Rayları'nın Türkiye tek yetkili distribütörlüğünü yapmaktadır.

Marazzi S.r.l, being the one of companies founded with a strong focus on the segment of the lifts guide rails and giving service in the lift sector for forty years, has the UNI EN ISO 9002:1994 quality certification in 1997 and the quality certification to the new standard UNI EN ISO 9001:2008 in 2008.

Bulut Makina is solely Turkey distributor of Marazzi S.r.l. Guide rails since the year of 2013.

Marazzi S.r.l, est l'une des entreprises spécialisée dans le secteur des rails de guidage, et offre des produits de bonne qualité depuis 40 ans Marazzi a obtenu le certificat de qualité en 1997 UNI EN ISO 9002:1994 et le certificat de qualité des nouvelles normes UNI EN ISO 9001:2008 en 2008.

Bulut Makina est l'unique distributeur en Turquie des Rails de Guidage de Marazzi S.r.l depuis 2013.

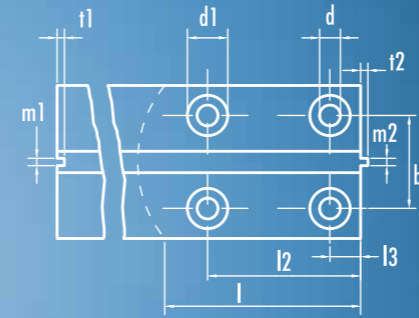
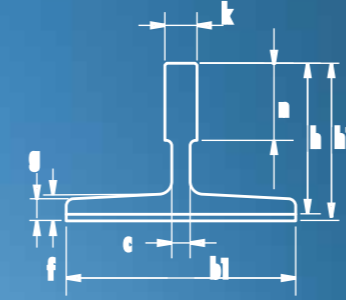

İşlenmiş Kılavuz Rayları

Machined Guide Rails / Rails de Guidage Usinés
Çelik / Steel / Acier

GM	ISO 7465 ed.09/97	b1	h1	h	k	n	c	g	f	m1	m2	t1	t2	d	d1	l	b3	l2	l3
GM890	T 89/B	89	62	61	15,88	33,4	10	7,9	11,1	6,4	6,37	7,14	6,35	13	26	156	57,2	114,3	38,1
GM975	T 90/B	90	75	74	16	42	10	8	10	6,4	6,37	7,14	6,35	13	26	156	57,2	114,3	38,1
GM125	T 125/B	125	82	81	16	42	10	9	12	6,4	6,37	7,14	6,35	17	33	156	79,4	114,3	38,1
GM127-1	T 127-1/B	127	88,9	88	15,88	44,5	10	7,9	11,1	6,4	6,37	7,14	6,35	17	33	156	79,4	114,3	38,1
GM127-2	T 127-2/B	127	88,9	88	15,88	50,8	10	12,7	15,9	6,4	6,37	7,14	6,35	17	33	156	79,4	114,3	38,1
GM127-3	-	127	88,9	88	15,88	50,8	14	12,7	15,9	6,4	6,37	7,14	6,35	17	33	156	79,4	114,3	38,1
GM140-1	T 140-1/B	140	108	107	19	50,8	12,7	12,7	15,9	6,4	6,37	7,14	6,35	21	40	193	92,1	152,4	31,8
GM140-2	T 140-2/B	140	102	101	28,6	50,8	17,5	14,5	17,5	6,4	6,37	7,14	6,35	21	40	193	92,1	152,4	31,8

Yüksek Kalitede İşlenmiş Kılavuz Rayları

High Quality Machined Guide Rails / Rails de Guidage Usinés avec Haute-technologie
Çelik / Steel / Acier

GE	ISO 7465 ed.09/97	b1	h1	h	k	n	c	g	f	m1	m2	t1	t2	d	d1	l	b3	l2	l3
GE125	T 125/BE	125	82	81	16	42	10	9	12	6,4	6,37	7,14	6,35	17	33	156	79,4	114,3	38,1
GE127-1	T 127-1/BE	127	88,9	88	15,88	44,5	10	7,9	11,1	6,4	6,37	7,14	6,35	17	33	156	79,4	114,3	38,1
GE127-2	T 127-2/BE	127	88,9	88	15,88	50,8	10	12,7	15,9	6,4	6,37	7,14	6,35	17	33	156	79,4	114,3	38,1
GE127-3	-	127	88,9	88	15,88	50,8	14	12,7	15,9	6,4	6,37	7,14	6,35	17	33	156	79,4	114,3	38,1
GE140-1	T 140-1/BE	140	108	107	19	50,8	12,7	12,7	15,9	6,4	6,37	7,14	6,35	21	40	193	92,1	152,4	31,8
GE140-2	T 140-2/BE	140	102	101	28,6	50,8	17,5	14,5	17,5	6,4	6,37	7,14	6,35	21	40	193	92,1	152,4	31,8

Yüksek Hızlı Asansörler İçin (> 2 mt/sn)

For High Speed Elevator (> 2 mt/sec) / Pour Ascenseurs à Grande Vitesse (> 2 mt/sec)

GE kılavuz rayları ISO7465 standardı "Yüksek Kaliteyle İşlenmiş Kılavuz rayları" BE sınıfına uygundur. Konfor hissini artırmak ve sessiz hareket garantisi verebilmek adına özellikle ray uçlarının işlenmesinde (h,k,m1,m2 ve ray ağız ile ray kızağı) ve ray hareketinin düzenlenmesinde sık toleranslar gerekmektedir.

GE guide rails are in accordance with ISO7465 Class BE "High Quality Machined Guide Rails". In order to increase the comfort and guarantee silent moving, tight tolerances are required especially in machining of ends (h, k, m1, m2 and centering of key and keyway) and straightening operations.

GE des rails de guidage sont conformes à la norme ISO7465 classe BE "Production des Rails de Guidage de haute qualité". Afin d'offrir plus de confort et de garantir un mouvement silencieux, des tolérances fréquentes sont requises dans la régulation du mouvement du rail, surtout dans la production des extrémités (h, k, m1, m2 et centrage de la clé et de la rainure de clavette) et des opérations de redressement.

Türkiye
TEK
Yetkili
Distribütörlüğü



1975 yılından beri hızla büyümesini sürdüren Xinda, 1995 yılında Çin'in ilk yürüyen merdiven motorunu geliştirdi. 2000 yılında, şu anda yaygınca kullanılan dişsiz makine modelini geliştirerek Çin'de pekçok ödül almaya hak kazandı. Ayrıca 800 ve 1000kg uygulamalarda 40 cm ve üzeri tahrik kasnağıyla birlikte kendir özlü halat kullanılabilmesi, makinanın iddali fiyatı yanında rekabetçi olmasını da sağlamaktadır. 9 yıl peş peşe müşteri memnuniyeti ve satış sonrası hizmetleri ödülünü kazanan Xinda, Bulut Makina'nın tecrübesiyle kullanıcılarının memnuniyetini ülkemizde de üst düzeyde tutmaktadır.

Xinda has been growing since 1975 as lift component manufacturer. It developed the first driving machines for escalators in 1995. Xinda developed and launched gearless machines in year 2000 as pioneer in the market. Today it manufactures robust and high quality gearless machines with competitive prices. Xinda won customer satisfaction and after-sale service awards for 9 consecutive years and it aims to keep the customer satisfaction at the highest level in our country through the experiences of Bulut Makina.

Xinda, qui a connu une croissance rapide depuis 1975, a développé la première machine d'escalier roulant Chinois en 1995. en 2000, Xinda a développé un Modèle pour la machine Gearless qui est aujourd'hui largement utilisé, et a reçu plusieurs prix dans son propre pays. Xinda produit les machines Gearless de haute qualité et robustesse, et spécialement les machines pour les applications de 800 et 1000 Kg, dont la compatibilité des poulies de 40 cm ou plus, avec les âmes en fibre standards, peuvent devenir en total plus compétitifs. Xinda qui a remporté le prix de la satisfaction client et le prix du meilleur service après vente 9 fois consécutives, maintient la satisfaction de ses utilisateurs au plus haut niveau dans notre pays grâce à l'expérience de Bulut Makina.

Türkiye
TEK
Yetkili
Distribütörlüğü

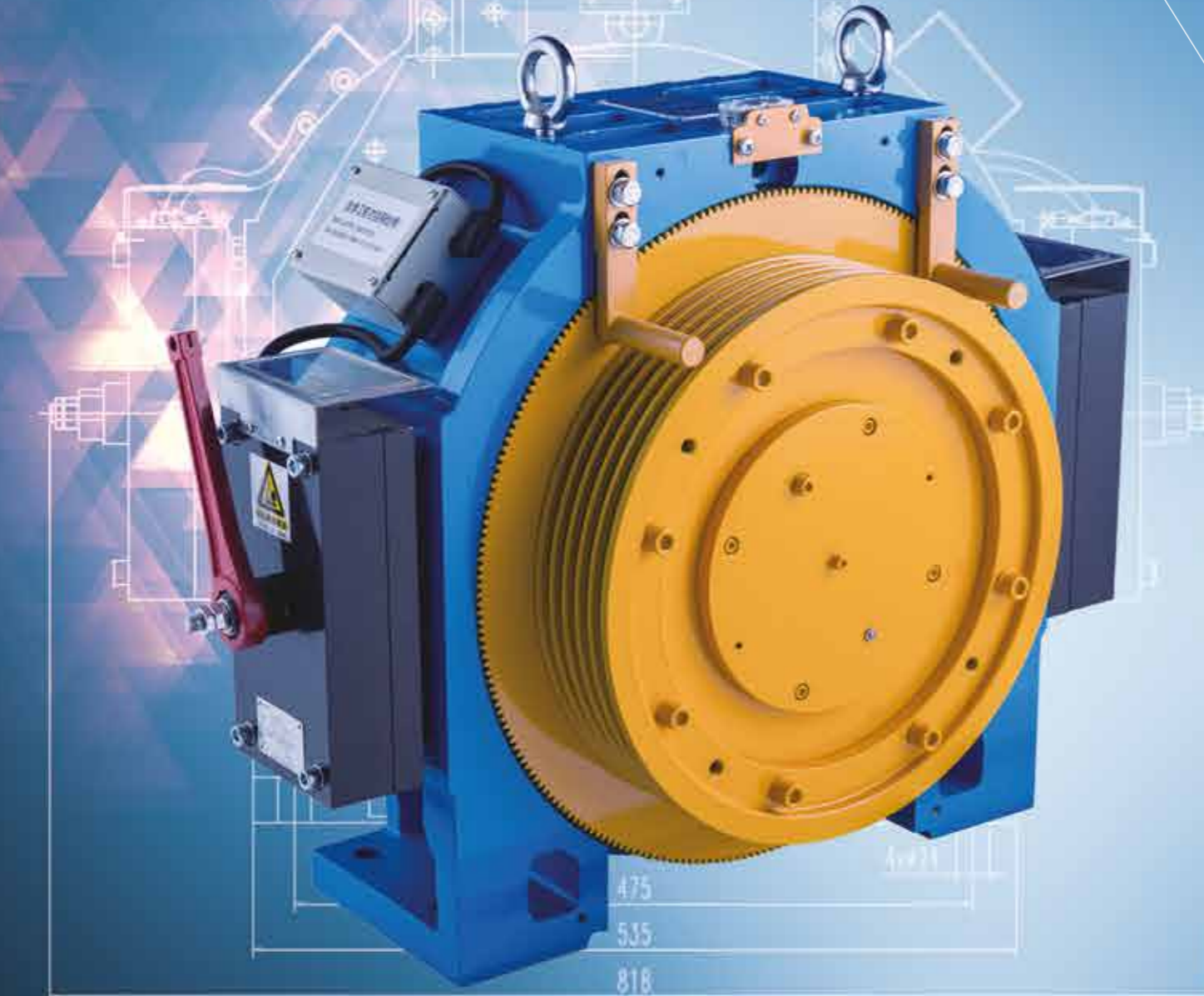

ASANSÖR MAKİNASI

LIFT MACHINE | MACHINE D'ASCENSEUR

ASANSÖR MAKİNASI

LIFT MACHINE | MACHINE D'ASCENSEUR



AYBEY
ELEKTRONİK

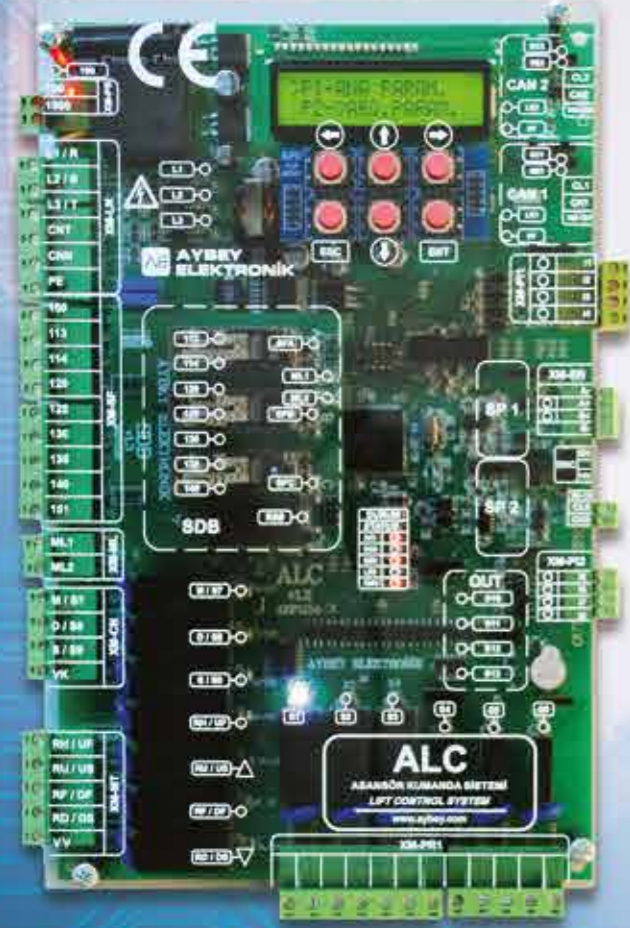

2000



ASANSÖR KUMANDA SİSTEMLERİ
LIFT CONTROL SYSTEMS | SYSTEMES DE CONTROLE D'ASCENSEUR

BUTON VE GÖSTERGE SİSTEMLERİ
BUTTON AND DISPLAY SYSTEMS | SYSTEMES DE BOUTON ET D'INDICATEUR