

bm
bulut makina



Orhanlı Mah. Katip Çelebi Cad. No: 17 34956 Tuzla - İstanbul - Türkiye
T: +90 (216) 394 50 50 (pbx) F: +90 (216) 394 50 54 E: sales@bulutmakina.com

www.bulutmakina.com



bm
bulut makina



1988 yılında kurulan Bulut Makina bugün 10.000m2 fabrikasında en son teknolojiyle üretimine devam etmektedir. 1990 yılından beri Fermator - İspanya otomatik kapıları ve 2000 yılından beri GMV - İtalya hidrolik ünitelerinin Türkiye distribütörlüğünü sürdürmekte olup, 2010 yılında Sicor - İtalya Asansör makinalarının ve 2013 yılında da Marazzi - İtalya raylarının Türkiye tek yetkili distribütörlüğüne de başlamıştır. Bulut Makina paket asansör ve her tip asansör malzemesi satışında yurtiçi ve yurtdışında sektördeki öncü firmalardandır.

Bulut Makina asansör sektöründe kalite ve güvenilirliği temsil etmesinin yanısıra, üretimde kullanılan malzeme kalitesi, "lego tipi" üretim bandı ve montaj tekniği, müşterisine sunduğu geniş ürün yelpazesıyla, müşterilerin özel projelerine akılcı çözümler getirmektedir. Konusunda uzman geniş bir mühendis kadrosuyla çalışmakta olup, satılan her ürünün satış sonrası teknik desteğini verebilecek tecrübeli mühendis ve teknisyen kadrosunu da bünyesinde barındırmaktadır.

Bulut Makina established in 1988 continues its manufacturing with the latest technology in its 10.000m2 factory, today. It has been preserving the Turkish distributorship of Fermator - Spain automatic doors starting from 1990 and GMV - Italy hydraulic units starting from 2000; and also started to distribute Sicor - Italy traction machines in 2010 and Marazzi guiderails as its exclusive distributor in 2013. Bulut Makina is one of the leader companies in Turkey which supply complete lift packages and also all kinds of lift components in both local and international markets.

Bulut Makina represents the quality and reliability in the lift market; besides works with its wide range of competent engineer cadre offering reasonable solutions for customers' special projects under favour of the material quality used in production, "lego type" mass production line and production techniques and the wide range of product presented to its customers; It also embodies the experienced engineer and technician cadre being able to give the technic support after the sale of every product.

Bulut Makina étant fondé en 1988 continue son production avec le technology de 100 % coupe au laser dans la fabrique de 10.000m2, aujourd'hui. Il préserve le distribution turque de Fermator - Espagne portes automatiques depuis 1990 et GMV - Italy unités hydrauliques depuis 2000 ; et aussi a commencé à distribuer Sicor - Italie machines en 2010 et Marazzi - Italie rails de guidage comme son distributeur exclusif in 2013. Bulut Makina est l'un des sociétés prépondérantes en Turquie que fournit les paquets complets d'ascenseur et aussi toutes les sortes des composants d'ascenseur dans les marchés locaux et internationaux.

Bulut Makina représente la qualité et la fiabilité dans le secteur d'ascenseur ; en outre travaille avec son cadre d'ingénieur competent qui propose les solutions raisonnables pour les projets spéciaux des clients à la faveur de la qualité de matériel appliqué à la production, la ligne masse de production @ type de lego D, le technique de montage et une chaine grande de produit soumise à ses clients ; et également comprend un cadre large d'ingénieur et technicien expérimenté qui peut donner le support technique apres le vente des chaque produit.

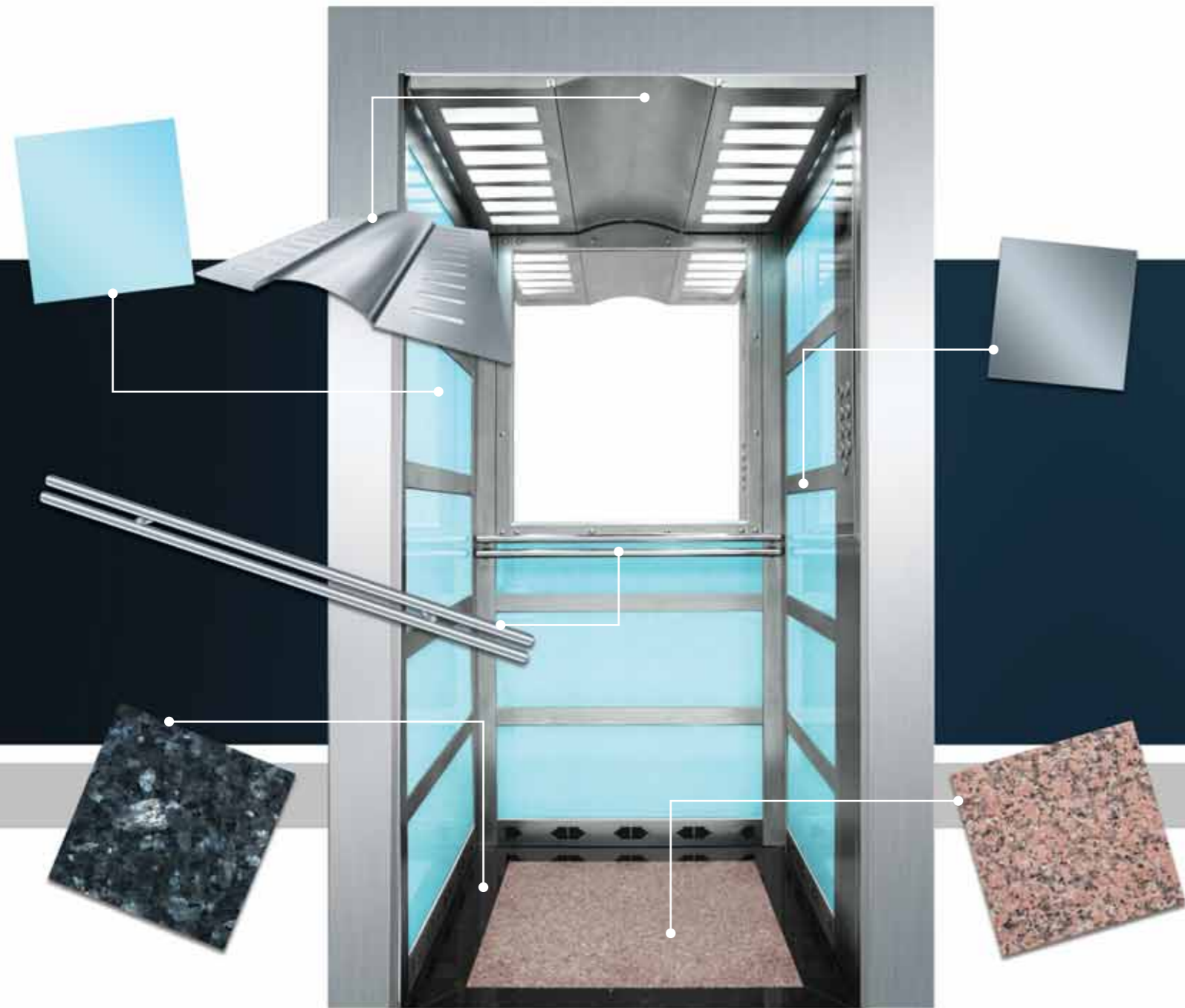

KABINLER

CABINS / CABINES



BK 160-101

- > Duvarlar **Boyuna Postforming Laminat**
Walls Vertical Postforming Laminate
Murs Postformage Laminant Vertical
- > Aksesuarlar **Paslanmaz**
Accessories Stainless Steel
Accessoires Inoxydable
- > Küpeşte **Paslanmaz Boru K1**
Handle Stainless Steel Tube K1
Poignée Tube Inoxydable K1
- > Tavan **Standart Tavan**
Ceiling Standart Ceiling
Plafond Plafond Standard
- > Taban **Rosa Porrino Doğal Granit**
Floor Natural Granite Rosa Porrino
Base Granit Naturel Rosa Porrino

Tüm kabinler farklı tavan, aksesuar, döşeme veya taban seçenekleri ile kombine edilebilir.

All cabins can be combined with different ceiling, accessories, floor/wall coating.

Toutes les cabines peuvent être combinées avec différent plafond, accessoire, base/revêtement mural.

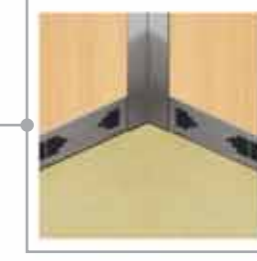
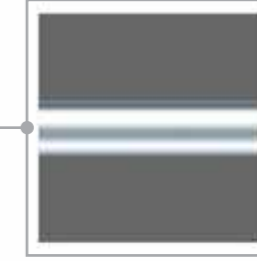
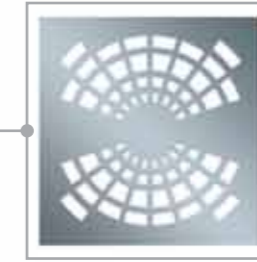

BK 60-102

- > Duvarlar **Yekpare Laminat**
Walls One Sheet Laminate
Murs Une-pièce Laminate
- > Aksesuarlar **Paslanmaz**
Accessories Stainless Steel
Accessoires Inoxydable
- > Küpeşte **Paslanmaz Boru K1**
Handle Stainless Steel Tube K1
Poignée Tube Inoxydable K1
- > Tavan **Kuasar A9**
Ceiling Quasar A9
Plafond Quasar A9
- > Taban **PVC**
Floor PVC
Base PVC

Tüm kabinler farklı tavan, aksesuar, döşeme veya taban seçenekleri ile kombine edilebilir.

All cabins can be combined with different ceiling, accessories, floor/wall coating.

Toutes les cabines peuvent être combinées avec différent plafond, accessoire, base/revêtement mural.



BK 160-201

- > Duvarlar **Enine Postforming Laminat**
Walls Horizontal Postforming Laminate
Murs Postformage Laminant Horizontal
- > Aksesuarlar **Paslanmaz**
Accessories Stainless Steel
Accessoires Inoxydable
- > Küpeşte **Paslanmaz Boru K1**
Handle Stainless Steel Tube K1
Poignée Tube Inoxydable K1
- > Tavan **Kuasar A9**
Ceiling Quasar A9
Plafond Quasar A9
- > Taban **Bianco Sardo Doğal Granit**
Floor Natural Granite Bianco Sardo
Base Granit Naturel Bianco Sardo

Tüm kabinler farklı tavan, aksesuar, döşeme veya taban seçenekleri ile kombine edilebilir.

All cabins can be combined with different ceiling, accessories, floor/wall coating.

Toutes les cabines peuvent être combinées avec différent plafond, accessoire, base/revêtement mural.

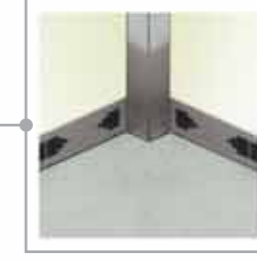
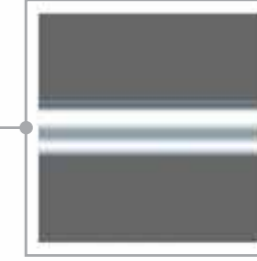
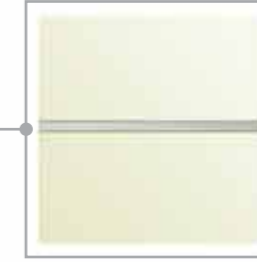
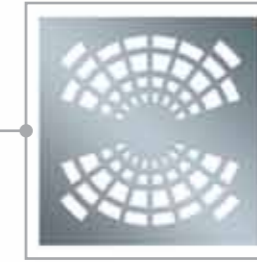

BK 90-201

- > Duvarlar **Enine Laminat**
Walls Horizontal Laminated
Murs Laminant horizontal
- > Aksesuarlar **Paslanmaz**
Accessories Stainless Steel
Accessoires Inoxydable
- > Küpeşte **Paslanmaz Boru K1**
Handle Stainless Steel Tube K1
Poignée Tube Inoxydable K1
- > Tavan **Kuasar A9**
Ceiling Quasar A9
Plafond Quasar A9
- > Taban **PVC**
Floor PVC
Base PVC

Tüm kabinler farklı tavan, aksesuar, döşeme veya taban seçenekleri ile kombine edilebilir.

All cabins can be combined with different ceiling, accessories, floor/wall coating.

Toutes les cabines peuvent être combinées avec différent plafond, accessoire, base/revêtement mural.



BK 110-101

- > Duvarlar **Boyuna Paslanmaz**
Walls *Vertical Stainless Steel*
Murs *Inoxydable Vertical*
- > Aksesuarlar **Paslanmaz**
Accessories *Stainless Steel*
Accessoires *Inoxydable*
- > Küpeşte **Paslanmaz Boru K1**
Handle *Stainless Steel Tube K1*
Poignée *Tube Inoxydable K1*
- > Tavan **Kuasar A8**
Ceiling *Quasar A8*
Plafond *Quasar A8*
- > Taban **Bianco Sardo Doğal Granit**
Floor *Natural Granite Bianco Sardo*
Base *Granit Naturel Bianco Sardo*

Tüm kabinler farklı tavan, aksesuar, döşeme veya taban seçenekleri ile kombine edilebilir.

All cabins can be combined with different ceiling, accessories, floor/wall coating.

Toutes les cabines peuvent être combinées avec différent plafond, accessoire, base/revêtement mural.



BK 120-201

- > Duvarlar **Postforming Paslanmaz/Laminat**
Walls *Postforming Stainless Steel/Laminate*
Murs *Postformage inoxydable/Laminant*
- > Aksesuarlar **Paslanmaz**
Accessories *Stainless Steel*
Accessoires *Inoxydable*
- > Küpeşte **Paslanmaz Boru K6**
Handle *Stainless Steel Tube K6*
Poignée *Tube Inoxydable K6*
- > Tavan **Centa**
Ceiling *Centa*
Plafond *Centa*
- > Taban **Rosa Porrino Doğal Granit**
Floor *Natural Granite Rosa Porrino*
Base *Granit Naturel Rosa Porrino*

Tüm kabinler farklı tavan, aksesuar, döşeme veya taban seçenekleri ile kombine edilebilir.

All cabins can be combined with different ceiling, accessories, floor/wall coating.

Toutes les cabines peuvent être combinées avec différent plafond, accessoire, base/revêtement mural.

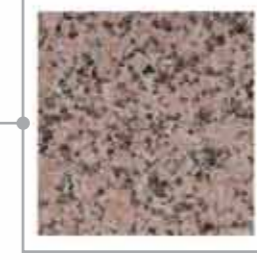
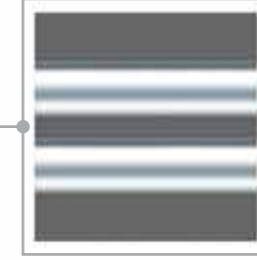
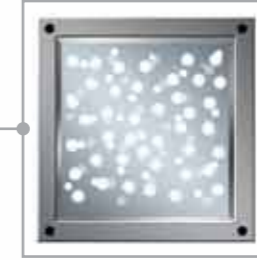



BK 130-201

> Duvarlar **Enine Lamine Cam**
Walls Horizontal Laminated Glass
Murs Verre Laminé Horizontal

> Aksesuarlar **Paslanmaz**
Accessories Stainless Steel
Accessoires Inoxydable

> Küpeşte **Paslanmaz Boru K6**
Handle Stainless Steel Tube K6
Poignée Tube Inoxydable K6

> Tavan **Kuasar Üst Bombe**
Ceiling Quasar Concave Up
Plafond Quasar Cambre Haut

> Taban **Rosa Porrino/Star Galaksi**
Floor Natural Granite
Base Rosa Porrino/Star Galaxy
Granit Naturel

Tüm kabinler farklı tavan, aksesuar, döşeme veya taban seçenekleri ile kombine edilebilir.

All cabins can be combined with different ceiling, accessories, floor/wall coating.

Toutes les cabines peuvent être combinées avec différent plafond, accessoire, base/revêtement mural.



BK 140-201

> Duvarlar **Lamine Cam/Beargrass**
Walls Laminated Glass/Beargrass
Murs Verre Laminé/Beargrass
Granit Naturel

> Aksesuarlar **Paslanmaz**
Accessories Stainless Steel
Accessoires Inoxydable

> Küpeşte **Paslanmaz Boru K6**
Handle Stainless Steel Tube K6
Poignée Tube Inoxydable K6

> Tavan **Kuasar Üst Bombe**
Ceiling Quasar Concave Up
Plafond Quasar Cambre Haut

> Taban **Star Galaksi Doğal Granit**
Floor Natural Granite Star Galaxy
Base Granit Naturel Star Galaxy

Tüm kabinler farklı tavan, aksesuar, döşeme veya taban seçenekleri ile kombine edilebilir.

All cabins can be combined with different ceiling, accessories, floor/wall coating.

Toutes les cabines peuvent être combinées avec différent plafond, accessoire, base/revêtement mural.

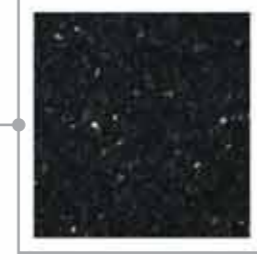
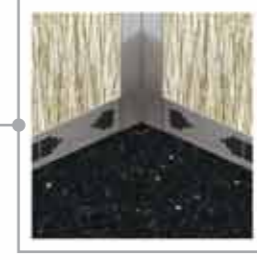
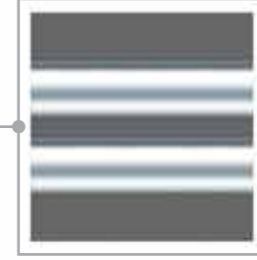
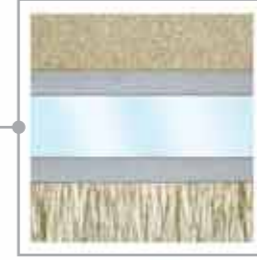



BY 110-101

- > Duvarlar **Boyuna Paslanmaz**
Walls *Vertical Stainless Steel*
Murs *Inoxydable vertical*
- > Aksesuarlar **Paslanmaz**
Accessories *Stainless Steel*
Accessoires *Inoxydable*
- > Küpeşte **Paslanmaz Boru K1**
Handle *Stainless Steel Tube K1*
Poignée *Tube Inoxydable K1*
- > Tavan **Kuasar Üst Bombe**
Ceiling *Quasar Concave Up*
Plafond *Quasar Cambre Haut*
- > Taban **PVC**
Floor *PVC*
Base *PVC*

Tüm kabinler farklı tavan, aksesuar, döşeme veya taban seçenekleri ile kombine edilebilir.

All cabins can be combined with different ceiling, accessories, floor/wall coating.

Toutes les cabines peuvent être combinées avec différent plafond, accessoire, base/revêtement mural.

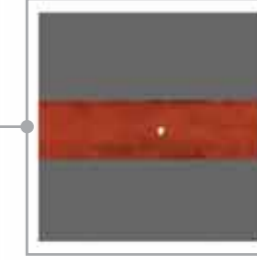
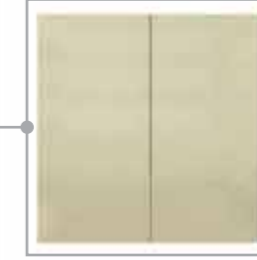

BY 70-101

- > Duvarlar **Elektrostatik Boyalı Sac**
Walls *Epoxy Painted Steel Sheet*
Murs *Tôle D'acier Epoxy Peint*
- > Aksesuarlar **Elektrostatik Boyalı Sac**
Accessories *Epoxy Painted Steel Sheet*
Accessoires *Tôle D'acier Epoxy Peint*
- > Küpeşte **Verzalit**
Handle *Verzalit*
Poignée *Verzalit*
- > Tavan **Standart Tavan**
Ceiling *Standart Ceiling*
Plafond *Plafond Standard*
- > Taban **PVC**
Floor *PVC*
Base *PVC*

Tüm kabinler farklı tavan, aksesuar, döşeme veya taban seçenekleri ile kombine edilebilir.

All cabins can be combined with different ceiling, accessories, floor/wall coating.

Toutes les cabines peuvent être combinées avec différent plafond, accessoire, base/revêtement mural.



Resimli lamine cam kabinler, pek çok farklı renk ve deseniyle size her türlü tasarımı ve kabin içi görselini seçme imkanı sağlar. Lamine cam kullanımı hem temizlik, hem de estetik anlamında ferah bir kabin ortamı sağlar.

In addition to having provide lots of different and unique design options, laminated glass cabins are also preferable with their ease of cleaning.

En plus d'avoir fournir beaucoup de différents et uniques options de conception, des cabines de verre feuilleté sont aussi préférable pour leur facilité de nettoyage.



BK 140-204

- > **Duvarlar** **Lamine Cam**
Walls Laminated Glass
Murs Le Verre Feuilleté
- > **Aksesuarlar** **Paslanmaz**
Accessories Stainless Steel
Accessoires Inoxydable
- > **Küpeşte** **Paslanmaz Boru K6**
Handle Stainless Steel Tube K6
Poignée Tube Inoxydable K6
- > **Tavan** **Centa**
Ceiling Centa
Plafond Centa
- > **Taban** **Bianco Sardo Doğal Granit**
Floor Natural Granite Bianco Sardo
Base Granit Naturel Bianco Sardo

Tüm kabinler farklı tavan, aksesuar, döşeme veya taban seçenekleri ile kombine edilebilir.

All cabins can be combined with different ceiling, accessories, floor/wall coating.

Toutes les cabines peuvent être combinées avec différent plafond, accessoire, base/revêtement mural.



PANORAMİK KABİNLER

PANORAMIC CABINS | CABINES PANORAMIQUES

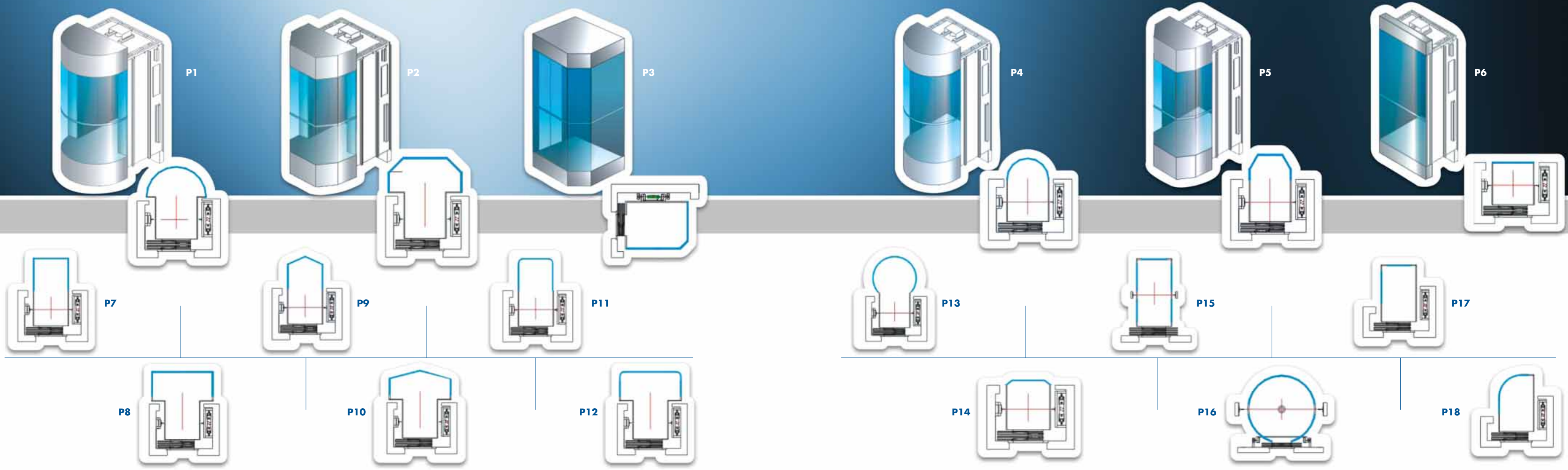

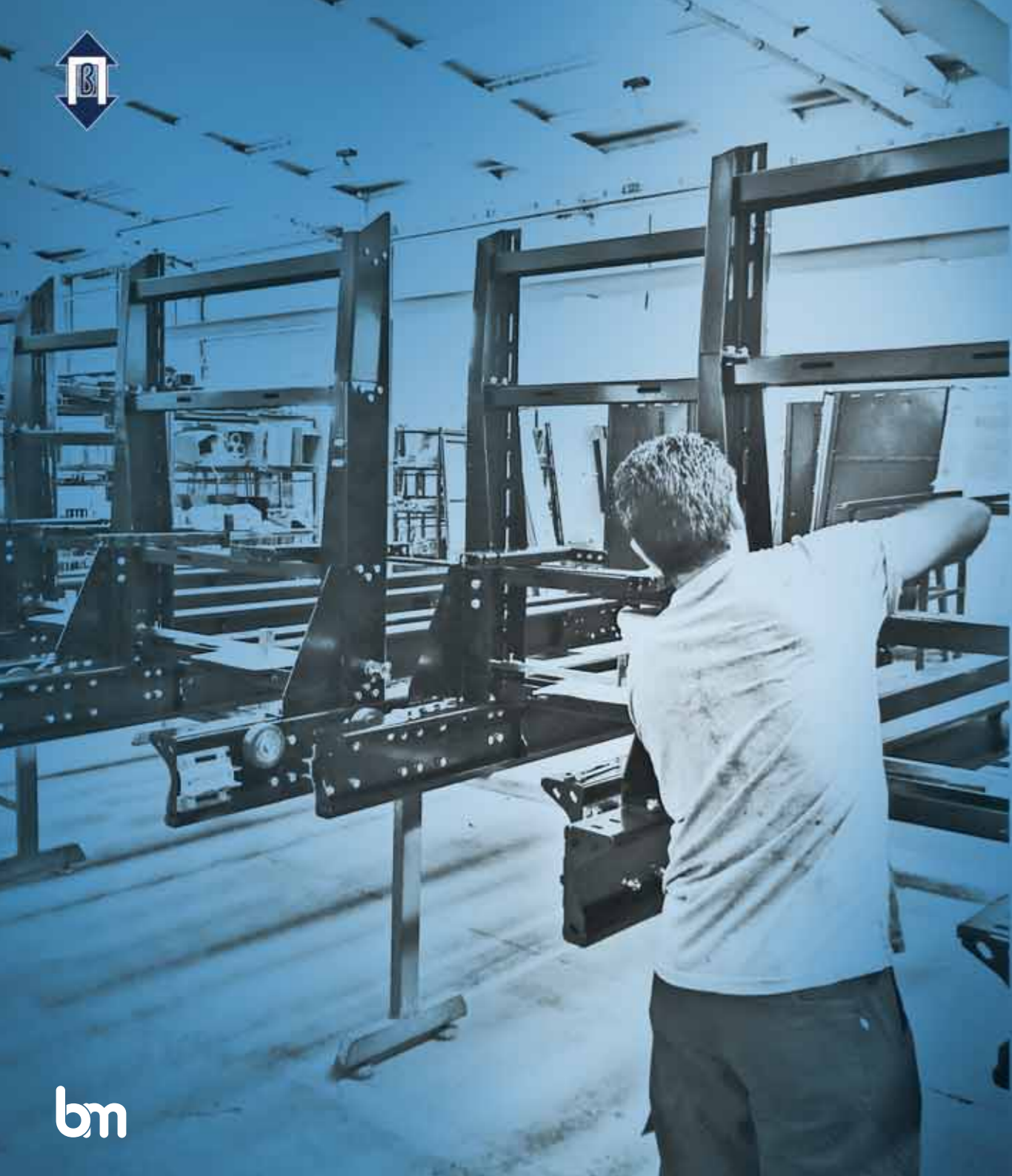

SÜSPANSİYONLAR - ŞASELER

CAR - MACHINE FRAMES / SUSPENSIONS - CHASSIS DE MACHINE

Süspansiyon üretimimiz tamamen lazer kesim saçlarla yapılmaktadır. Semer tipi ve Mekanik Süspansiyonlarımız mukavemet analizi yapılmış olan standart saç büküm profillerle tasarlanmıştır. En ufak vida, delik ve perçine kadar yıllar sonra dahi yedek parçası verilebilecek özelliğe sahip olup, farklı süspansiyon olanakları mevcuttur;

- 1) Standart süspansiyonlar (kuyu dibi 800mm ve üzeri)
- 2) Özel tasarım süspansiyonlar (kuyu dibi 800mm'nin altında)
- 3) Asansör Direktifine uygun çalışan özel sistemler (Kuyu dibi 250mm'ye kadar)
- 4) Makina Direktifine uygun çalışan özel sistemler (Kuyu dibi 100mm'ye kadar)

Our car frame production is realized by way of completely laser-cut metal sheets. L type and Mechanic car frames are designed with standard sheet spinning profiles whose analyses of durability are practised. They have such a speciality that their tiniest spare parts like screw, hole and rivet can be provided even after years, also contain in different opportunities;

- 1) Standard car frames (pit depth of 800mm and upper)
- 2) Special design car frames (pit depth under 800mm)
- 3) Special systems operating as per Lift Directive (pit depth up to 250mm)
- 4) Special systems operating as per Machine Directive (pit depth up to 100mm)

Notre production de suspension est réalisée par l'entremise des plaques métaux complètement découpées au laser. L type et Mécanique suspensions sont désignées avec les profils standards des plaques fléchies dont les analyses de durabilité sont pratiqués. Ils ont une telle spécialité que leur parts suppléants moindres comme vis, trou et rivet peuvent être fournis même après les années; et aussi contiennent des opportunités différentes;

- 1) Suspensions standards (le fond de puits de 800mm et plus)
- 2) Suspensions désignées spécialement (le fond de puits en dessous de 800mm)
- 3) Systèmes spéciaux opérants conformément a la directive d'ascenseur (le fond de puits jusqu'à 250mm)
- 4) Systèmes spéciaux opérants conformément a la directive de machine (le fond de puits jusqu'à 100mm)

DEKORASYON MALZEMELERİ

DECORATION MATERIALS / MATERIALS DE DECORATION

Paslanmazlar

Stainless Steels / Inoxydables



Satine
Hairline



Noktalı
Dotted



Kare
Square



Deri
Leather



Mat Ayna
Dull Mirror

Dekoratif Paslanmazlar

Decorative Stainless Steels / Aciers Inoxydables Décoratifs



YH-M



M-GD



YH-E03



YH-GE08



YH-E02



YH-GE02



YH-E10



H-RG

Küpeşterler

Handles / Poignées

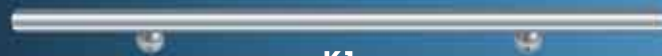

K1



K2



K3



K4



K5



K6

KUASAR TAVAN MODELLERİ

QUASAR CEILING MODELS / MODELES DE QUASAR PLAFOND



A1



A2



A5



A6



A8



A9



A11



A12



A13



A17



A18



A19



A20



A22



A23



A24



A25



A26



A27



A28



A29

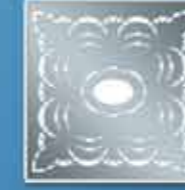

A30



A31



A32



A33



A34



Üst Bombeli
Concave Up
Haut-Cambre



Alt Bombeli
Convex Curved
Sous-Cambre



Standart Tavan
Standart Ceiling
Plafond Standard

DUVAR DÖŞEME MALZEMELERİ

WALL COATING MATERIALS | MATERIALS DE REVETEMENT MURAL

TABAN DÖŞEME MALZEMELERİ

FLOOR COATING MATERIALS | MATERIALS DE REVETEMENT DE BASE



Gentaş 3133 Gentaş 4204 Gentaş 4206 Gentaş 4207 Gentaş 4251 Gentaş 4253 Gentaş 4260 Gentaş 4267



Gentaş 4346 Gentaş 4496 Gentaş 5330 Gentaş 5414 Gentaş 5427 Gentaş 7303 ASD 2007 ASD 2008



ASD 2011 ASD 2016 ASD 2018 ASD 2020 ASD 2022 ASD 2028 ASD 2035 ASD 3108

Doğal Granit

Natural Granite | Granit Naturel



Nero Zimbabwe Star Galaxy Blue Pearl Verde Guatemala Santiago Red Carmen Red Rosa Porrino Bianco Sardo

Dekoratif PVC Karolar

Decorative PVC Tiles | PVC Carreaux Décoratifs



3714 ES-5 1341-6 1223

PVC Kaplamalar

PVC Coatings | PVC Revêtements



Gri Gray Sarı Yellow Kahve Brown

Metal Kaplamalar

Metal Coatings | Revêtements Métallique



Baklavali Paslanmaz Diamond Shaped St. Steel Baklavali Alüminyum Diamond Shaped Aluminum Baklavali Saç Diamond Shaped Sheet Steel



KAPI SİSTEMLERİ

DOOR SYSTEMS / SYSTEMES de PORTE



Fermator firmasıyla 1990'ten bu yana olan distribütörlük anlaşmamızla başlayan tam otomatik asansör kapılarındaki deneyimimizi; 2009 yılında başladığımız kendi markamız MB otomatik kapı üretimiyle piyasanın hizmetine sunduk. MB kapımız öncelikle dünya pazarlarında üretilmeyen özel serilerin üretilmesi amaçlanarak imalata sunuldu. Bununla birlikte seri üretim mekanizmalar ve operatörler de yapıldı. MB kat mekanizma ve kabin operatörleri 600 mm'den 6000 mm'e kadar, Standart Seri, İnce Seri, Ekstra İnce Seri ve Ağır Hizmet-Yoğun Trafik olmak üzere dört ana grupta üretilmektedir.

We released to the market our experience in automatic lift doors beginning with our agreement of Fermator's Turkey distributorship since 1990 owing to the production of our own brand MB automatic doors which we started in 2009. Firstly, our MB doors are submitted to the production by aiming to manufacture the special series which weren't produced in the worldwide manufacturers' product range. Besides, it is also manufactured the mass production mechanism and operators. MB landing mechanisms and cabin operators, from 600 mm to 6000 mm, are produced fundamentally under four groups such as Standard, Thin, Extra Thin and Heavy Duty series.

Nous présentons au marché notre expérience dans les portes automatiques d'ascenseur commencées avec notre accord de Fermator distribution Turque depuis 1990; grâce à la production de notre propre marque MB portes automatiques que l'on a débuté en 2009. D'abord, nos MB portes sont soumises à la production en proposant à produire les séries spéciaux qui n'ont pas été produits dans la gamme productive des producteurs au monde entier. En outre, il est aussi produit les mécanismes et operateurs à la production en série. MB mécanismes de porte et operateurs de cabine, de 600 mm à 6000 mm, sont produits essentiellement sous quatre groupes comme les séries Standards, Minces, Extras Minces et Séries de Service Lourd.





Kasasız Sistem
Without Frame
Sans Cadre



Söveli Kasa
Frame With Jamb
Cadre Avec Jambage





VVF Kapi Kontrol Ünitesi
VVF Door Control Unit
VVF Unité Contrôlable Du Porte

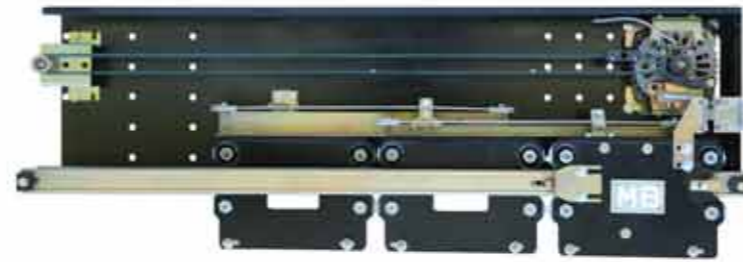



YARI OTOMATİK KAPILAR

SWING DOORS / PORTES SEMI-AUTOMATIQUE

Çift Kanat ESB Kapılar

Double Wing EP Doors / Portes EP aux Ailes Doubles



Tek Kanat Paslanmaz Kapılar

Single Wing St. Steel Doors / Portes Inoxydables à Seule Aile



Çift Kanat Paslanmaz Kapılar

Double Wing St. Steel Doors / Portes Inoxydable aux Ailes Doubles



Dört Panel Katlamalı Kapı

Four Panels Folding Door / Porte Pliante de Quatre Panels

A Serisi

A Series / A Série



B Serisi

B Series / B Série



Tek Kanat ESB Kapılar

Single Wing EP Doors / Portes EP à Seule Aile



MB
OTOMATİK KAPI

SICOR

AYBEY
ELEKTRONİK

GMV
LIFT SYSTEMS

bm
bulut makina

B

MARAZZI

Fermator
AUTOMATIC DOORS FOR LIFTS

欣达
XINDA

DİSTRİBÜTÖRLÜKLER
DISTRIBUTORSHIPS / DISTRIBUTIONS

25
YIL
Anniversary
Anniversaire



OTOMATİK KAPI SİSTEMLERİ

AUTOMATIC DOOR SYSTEMS / SYSTEMES DE PORTE AUTOMATIQUE

Fermator, otomatik asansör kapıları üretiminde dünya çapındaki lider firmalardan biridir. Fermator, 1977'de Reus - İspanya'da başlayan otomatik kapı üretimine İspanya merkezli olarak İspanya, Çin, İtalya, Brezilya, Polonya gibi pek çok ülkedeki üretim tesisleriyle devam etmektedir. Ürünlerini 90'a aşkın ülkeye ihraç etmektedir.

Bulut Makina, 25 yıldır Fermator'un Türkiye distribütörlüğünü yapmaktadır.

Fermator are one of the leading companies on a worldwide level in the manufacturing of automatic doors for lifts. Fermator continues the production of automatic doors began in Reus - Spain and in 1977 with headquarters in Spain and their production plants, located in countries such as Spain, Italy, China, Poland and Brazil among others, they deliver their products to over 90 countries.

Bulut Makina is Turkey's main distributor of Fermator automatic doors in last 25 years.

Fermator est l'un des sociétés prépondérantes dans le monde entier à la fabrication de portes automatiques pour ascenseurs. Fermator continue sa production des portes automatiques commencées à Reus - Espagne en 1977 avec les sièges sociaux en Espagne et leur usines situées dans les pays comme Espagne, Italie, Chine et Brésil parmi autres, ils délivrent leur produits aux plus de 90 pays.

Bulut Makina est le principal distributeur de Fermator portes automatiques dans la Turquie dans les 25 dernières années.





VVVF Kabin Operatörü
VVVF Cabin Operator
VVVF Opérateur de Cabine



50/11 Serisi
50/11 Series
50/11 Série



40/10 Serisi
40/10 Series
40/10 Série





HİDROLİK ÜNİTE VE EKİPMANLARI

HYDRAULIC UNITS AND EQUIPMENTS / UNITE HYDRAULIQUE ET EQUIPEMENTS

GMV, 1958'de Milano - İtalya'da başlayan asansör sektörü macerasına dünyanın en fazla kullanılan asansör hidrolik ünitesi üreticisi olarak devam etmektedir. GMV, üretiminin her aşamasında yüksek teknolojinin sunduğu olanaklardan faydalanmasının yanı sıra, modern asansör sektöründe var olan pek çok gereksinimi karşılayacak konumdadır. Emniyet, şıklık, çok yönlülük ve ergonomik kullanım avantajları, GMV'yi tasarımcılar ve montaj firmaları açısından en ideal çözüm yolu haline getirmektedir.

Bulut Makina, 2000 yılından beri GMV Hydraulics firmasının tek yetkili Türkiye distribütörlüğünü yapmaktadır.

GMV continues its way in lift sector as the first rank in lift hydraulics in the worldwide, which started in Milan - Italy factory in 1958. GMV benefits from the opportunities of high technology for each process of its manufacturing and also is in the position of meeting many requirements in modern lift sector. The advantages of safety, elegance, versatility and economical usage make GMV the most ideal solution for designers and installers.

Bulut Makina is solely Turkey distributor of GMV hydraulics since the year of 2000.

GMV continue son chemin dans le segment d'ascenseur commencé à Italie - Milano en 1958 comme le Producer de l'unité hydraulique utilisée maximales sur le monde. GMV profite des opportunités de l'haute-technologie pour chaque processus de sa production et aussi, est dans la position de répondre à beaucoup des exigences dans le secteur modern d'ascenseur. Les avantages de sécurité, élégance, versatilité et usage économique devient GMV à la plus idéale solution pour designers et installateurs.

Bulut Makina est le distributeur exclusif en Turquie de GMV Hydrauliques depuis 2000.

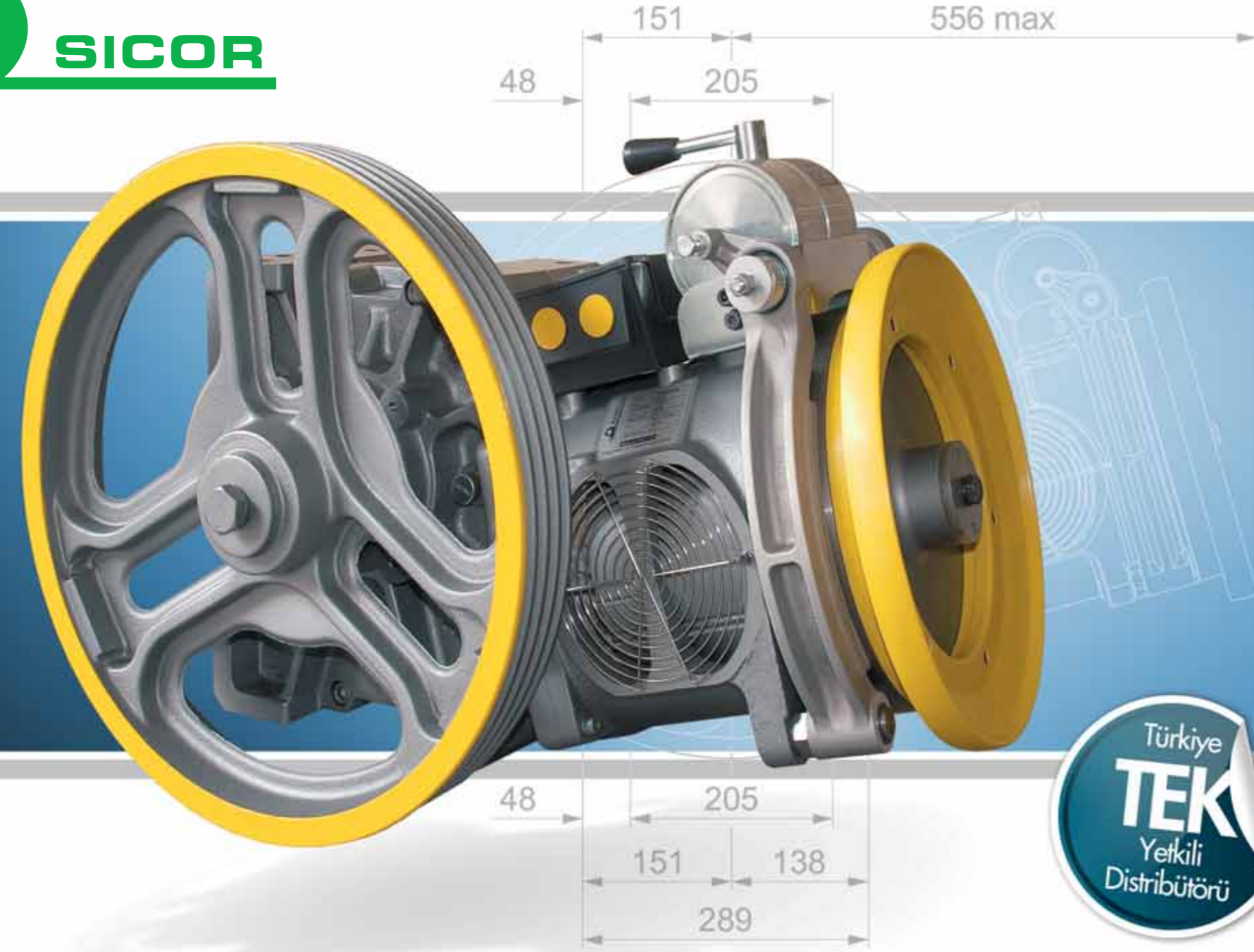

1982'de asansör sektöründen bir grup girişimci tarafından, insan ve yük asansörleri için yüksek kaliteli asansör makineleri üretmek amacıyla kurulan Sicor S.p.A, Rovereto - İtalya'daki üretim tesisinde tüm sistemler için emniyeti sağlayan ve teknolojik çözümler sunan redüktörlü ve dişlisiz elektrikli asansör makine sistemleri üretmektedir.

Bulut Makina, 2010 yılından itibaren Sicor Asansör Makineleri'nin Türkiye tek yetkili distribütörlüğünü yürütmektedir.

Sicor S.p.A. founded with a precise mission to produce high quality elevator traction machines for persons and goods by a group of entrepreneurs in the elevator segment in 1982, manufactures a complete range of gears and gearless elevator traction systems presenting technologic solutions and ensuring the safety for all types of system at its production plant in Rovereto - Italy.

Bulut Makina is solely Turkey distributor of Sicor S.p.A. traction machines since the year of 2010.

Sicor S.p.A. étant fondé avec une mission précise pour produire les machines d'ascenseur avec haute qualité pour personnes et biens par un groupe des entrepreneurs dans le segment d'ascenseur en 1982, produit les systemes de machines électriques avec réducteur et sans réducteur présentant les solutions technologiques et assurant la sécurité aux tous les types de systeme dans la fabrique à Rovereto - Italie.

Bulut Makina est le distributeur exclusif en Turquie de Sicor machines d'ascenseur depuis 2010.



Soğuk Çekme Kılavuz Rayları

Cold Drawn Guide Rails / Rails de Guidage Étirés à Froid
Çelik / Steel / Acier

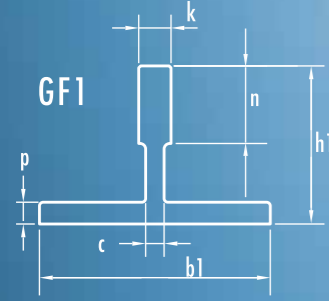

GF1	ISO 7465 ed.09/97	b1	h1	h	k	n	c	g	p	m1	m2	t1	t2	d	d1	l	b3	l2	l3
GF509	-	50	50	-	9	35	7,5	-	6,5	3	2,95	3,5	3	9	-	-	30	75	25
GF765	T 70-1/A	70	65	-	9	34	6	-	7	3	2,95	3,5	3	13	-	128	42	105	25
GF770	-	70	70	-	9	35	8	-	8,5	3	2,95	3,5	3	13	-	123	43	90	30
GF762	T 75-3/A	75	62	-	10	30	8	-	7,5	3	2,95	3,5	3	13	-	123	43	90	30

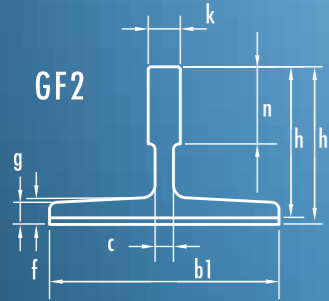

GF2	ISO 7465 ed.09/97	b1	h1	h	k	n	c	g	f	m1	m2	t1	t2	d	d1	l	b3	l2	l3
GF654	-	65	54	-	8	20	5	4	6	2	1,95	2,5	2	11	-	-	38	75	25
GF829	T 82/A	82,5	68,25	-	9	25,4	7,5	6	8,25	3	2,95	3,5	3	13	26*	111	50,8	81	27
GF890	T 89/A	89	62	61*	15,88	33,4	10	7,9	11,1	6,4	6,37	7,14	6,35	13	26*	156	57,2	114,3	38,1
GF975	T 90/A	90	75	74*	16	42	10	8	10	6,4	6,37	7,14	6,35	13	26*	156	57,2	114,3	38,1
GF125	T 125/A	125	82	81*	16	42	10	9	12	6,4	6,37	7,14	6,35	17	33*	156	79,4	114,3	38,1

İtalya'da asansör rayları odaklı olarak kurulan ilk firmalardan olan ve 40 yılı aşkın süredir asansör sektörüne hizmet veren Marazzi S.r.l, 1197'de UNI EN ISO 9002:1994 kalite sertifikası ve 2008'de yenilenen UNI EN ISO 9001:2008 kalite sertifikalarının sahibidir.

Bulut Makina, 2013 yılı itibarıyla Marazzi Asansör Rayları'nın Türkiye tek yetkili distribütörlüğünü yapmaktadır.

Marazzi S.r.l, being the one of companies founded with a strong focus on the segment of the lifts guide rails and giving service in the lift sector for forty years, has the UNI EN ISO 9002:1994 quality certification in 1997 and the quality certification to the new standard UNI EN ISO 9001:2008 in 2008.

Bulut Makina is solely Turkey distributor of Marazzi S.r.l. Guide rails since the year of 2013.

Marazzi S.r.l., étant l'un des sociétés premiers fondées avec une concentration forte sur le segment des rails de guidage pour ascenseurs et servant dans le secteur d'ascenseur pendant quarante ans, possède le certificate de qualité UNI EN ISO 9002:1994 en 1997 et le certificate de qualité accordant avec standard nouveau UNI EN ISO 9001:2008 en 2008.

Bulut Makina est le distributeur exclusif en Turquie de Marazzi rails de guidage d'ascenseur depuis 2013.

İşlenmiş Kılavuz Rayları

Machined Guide Rails / Rails de Guidage Usinés
Çelik / Steel / Acier

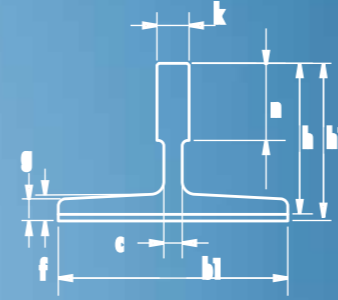

GM	ISO 7465 ed.09/97	b1	h1	h	k	n	c	g	f	m1	m2	t1	t2	d	d1	l	b3	l2	l3
GM890	T 89/B	89	62	61	15,88	33,4	10	7,9	11,1	6,4	6,37	7,14	6,35	13	26	156	57,2	114,3	38,1
GM975	T 90/B	90	75	74	16	42	10	8	10	6,4	6,37	7,14	6,35	13	26	156	57,2	114,3	38,1
GM125	T 125/B	125	82	81	16	42	10	9	12	6,4	6,37	7,14	6,35	17	33	156	79,4	114,3	38,1
GM127-1	T 127-1/B	127	88,9	88	15,88	44,5	10	7,9	11,1	6,4	6,37	7,14	6,35	17	33	156	79,4	114,3	38,1
GM127-2	T 127-2/B	127	88,9	88	15,88	50,8	10	12,7	15,9	6,4	6,37	7,14	6,35	17	33	156	79,4	114,3	38,1
GM127-3	-	127	88,9	88	15,88	50,8	14	12,7	15,9	6,4	6,37	7,14	6,35	17	33	156	79,4	114,3	38,1
GM140-1	T 140-1/B	140	108	107	19	50,8	12,7	12,7	15,9	6,4	6,37	7,14	6,35	21	40	193	92,1	152,4	31,8
GM140-2	T 140-2/B	140	102	101	28,6	50,8	17,5	14,5	17,5	6,4	6,37	7,14	6,35	21	40	193	92,1	152,4	31,8

Yüksek Kalitede İşlenmiş Kılavuz Rayları

High Quality Machined Guide Rails / Rails de Guidage Usinés avec Haute-technologie
Çelik / Steel / Acier

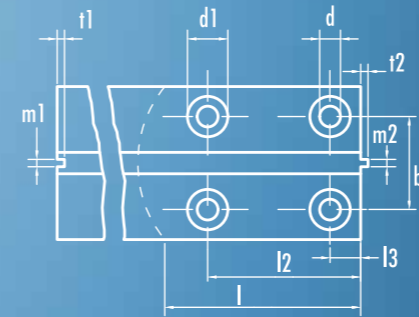

GE	ISO 7465 ed.09/97	b1	h1	h	k	n	c	g	f	m1	m2	t1	t2	d	d1	l	b3	l2	l3
GE125	T 125/BE	125	82	81	16	42	10	9	12	6,4	6,37	7,14	6,35	17	33	156	79,4	114,3	38,1
GE127-1	T 127-1/BE	127	88,9	88	15,88	44,5	10	7,9	11,1	6,4	6,37	7,14	6,35	17	33	156	79,4	114,3	38,1
GE127-2	T 127-2/BE	127	88,9	88	15,88	50,8	10	12,7	15,9	6,4	6,37	7,14	6,35	17	33	156	79,4	114,3	38,1
GE127-3	-	127	88,9	88	15,88	50,8	14	12,7	15,9	6,4	6,37	7,14	6,35	17	33	156	79,4	114,3	38,1
GE140-1	T 140-1/BE	140	108	107	19	50,8	12,7	12,7	15,9	6,4	6,37	7,14	6,35	21	40	193	92,1	152,4	31,8
GE140-2	T 140-2/BE	140	102	101	28,6	50,8	17,5	14,5	17,5	6,4	6,37	7,14	6,35	21	40	193	92,1	152,4	31,8

Yüksek Hızlı Asansörler için (> 2 mt/sn)

For High Speed Elevator (> 2 mt/sec) / Pour Ascenseurs à Grande Vitesse (> 2 mt/sec)

GE kılavuz rayları ISO7465 standardı "Yüksek Kaliteyle İşlenmiş Kılavuz rayları" BE sınıfına uygundur. Konfor hissini artırmak ve sessiz hareket garantisi verebilmek adına özellikle ray uçlarının işlenmesinde (h,k,m1,m2 ve ray ağız ile ray kızıağı) ve ray hareketinin düzenlenmesinde sık toleranslar gerekmektedir.

GE guide rails are in accordance with ISO7465 Class BE "High Quality Machined Guide Rails". In order to increase the comfort and guarantee silent moving, tight tolerances are required especially in machining of ends (h, k, m1, m2 and centering of key and keyway) and straightening operations.

GE rails de guidage sont conformément à ISO7465 Classe BE "Rails de guidage usiné avec haute-technologie". Afin d'augmenter le confort et de garantir le mouvement silencieux, les tolérances serrées sont nécessaires dans notamment l'usinage des fins (h, k, m1, m2 et bosse de rail et son voie) et dans l'amélioration des opérations.







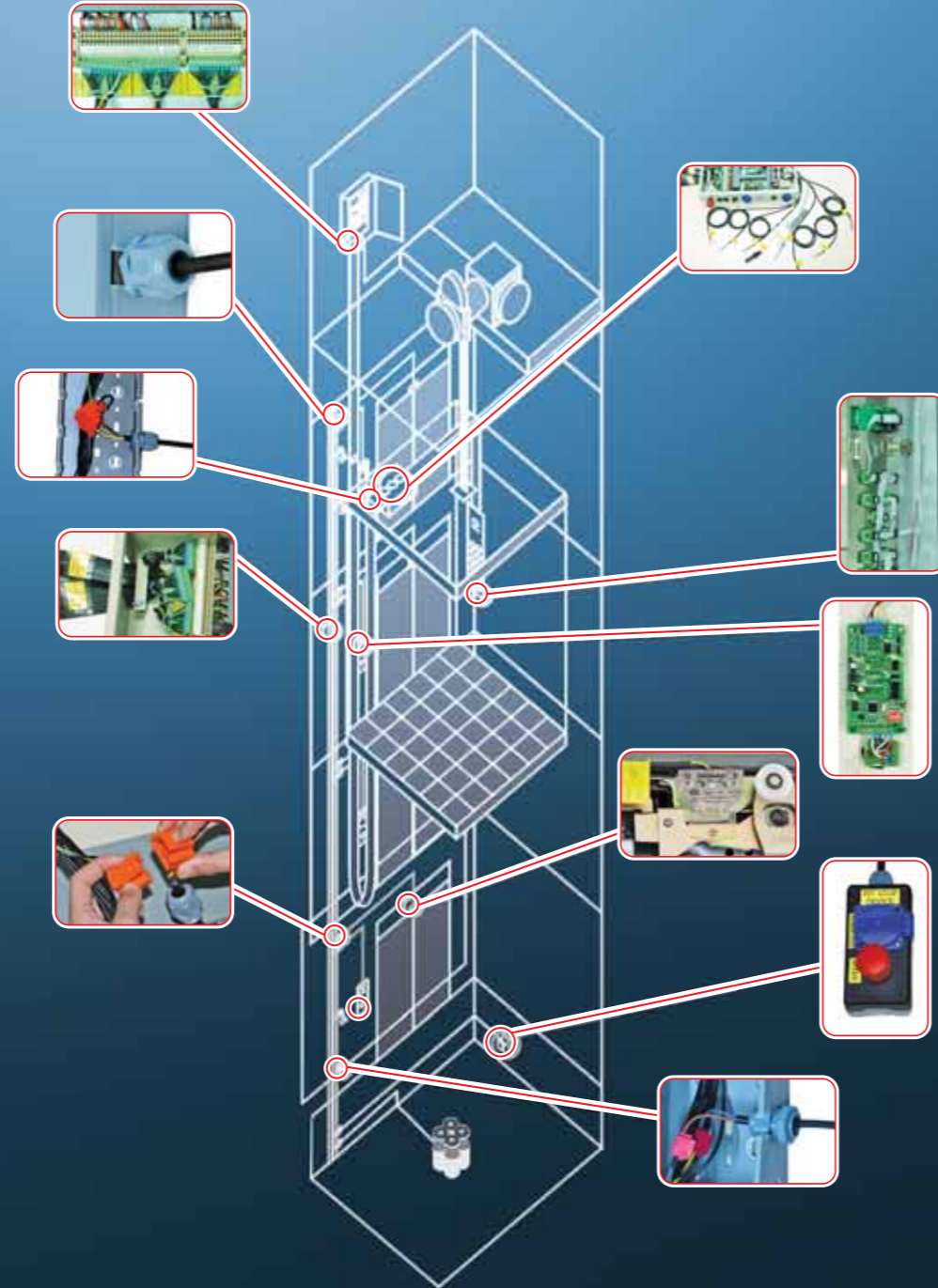

ASANSÖR KONTROL SİSTEMLERİ

LIFT CONTROL SYSTEMS | SYSTEMES DE CONTROLE D'ASCENSEUR

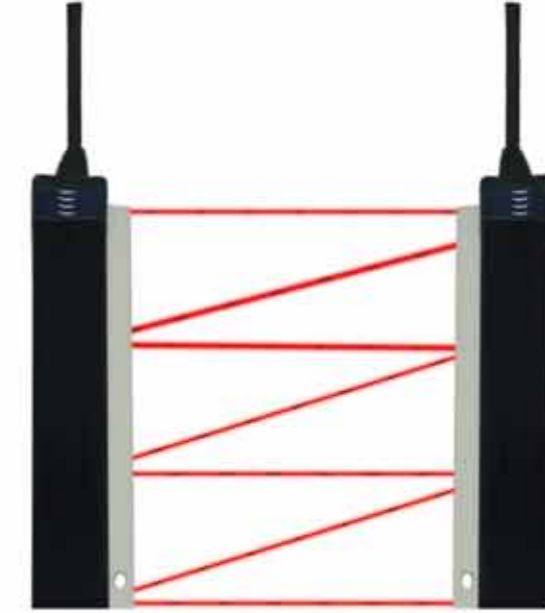

PAKET ASANSÖR

COMPLETE LIFT PACKAGE | PAQUET COMPLET D'ASCENSEUR



Bulut Makina, uzun yıllara dayanan tecrübesiyle; dünyanın ve Türkiye'nin kendi sektöründe lider olan markaları ve hem yurtiçi hem de yurtdışı tanınan geniş üretim yelpazesıyla tüm müşterilerine ihtiyaçlarına uygun özel çözümler sunmakta ve müşterilerinin A dan Z ye tüm ihtiyacının Bulut Makina paket asansörleriyle tek bir noktadan karşılanmasını sağlamaktadır.

Bulut Makina, offers customized products that are being produced according to the customer requirements and provides solutions for all of those necessary requirements for complete lift packages, through its long-term experience in the industry. Moreover, a wide range of both domestic and globally-known branded products are also being supplied by Bulut Makina.

Bulut Makina, propose des produits personnalisés qui sont produites selon les exigences du client et fournit des solutions pour l'ensemble de ceux exigences nécessaires pour les paquets de ascenseur complètes, à travers sa longue expérience dans l'industrie. En outre, une large gamme de produits nationaux et à l'échelle mondiale connues des marques sont également fournies par Bulut Makina.

ÖDÜL VE SERTİFİKALAR

PRIZE AND CERTIFICATES | PRIX ET CERTIFICATS



TSE Sürdürülebilir Kalite Anlayışı ile Hizmet Veren Kuruluşlar Altın Ödülü (2013)

